

Silicon Diffused Power Transistor

BU4506DZ

GENERAL DESCRIPTION

Enhanced performance, new generation, high-voltage, high-speed switching npn transistor in a plastic full-pack envelope with integrated damper diode intended for use in horizontal deflection circuits of colour television receivers. Features exceptional tolerance to base drive and collector current load variations resulting in a very low worst case dissipation.

QUICK REFERENCE DATA

SYMBOL	PARAMETER	CONDITIONS	TYP.	MAX.	UNIT
V_{CESM}	Collector-emitter voltage peak value	$V_{BE} = 0$ V	-	1500	V
V_{CEO}	Collector-emitter voltage (open base)		-	800	V
I_C	Collector current (DC)		-	5	A
I_{CM}	Collector current peak value		-	8	A
P_{tot}	Total power dissipation	$T_{hs} \leq 25$ °C	-	32	W
V_{CEsat}	Collector-emitter saturation voltage	$I_C = 3.0$ A; $I_B = 0.75$ A	-	3	V
I_{Csat}	Collector saturation current	$f = 16$ kHz	3.0	-	A
V_F	Diode forward voltage	$I_F = 3.0$ A	1.55	1.9	V
t_f	Fall time	$I_{Csat} = 3.0$ A; $f = 16$ kHz	300	400	ns

PINNING - SOT186A

PIN	DESCRIPTION
1	base
2	collector
3	emitter
case	isolated

PIN CONFIGURATION

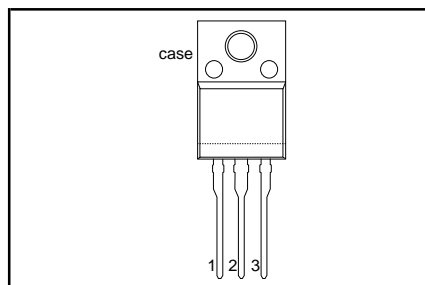

SYMBOL

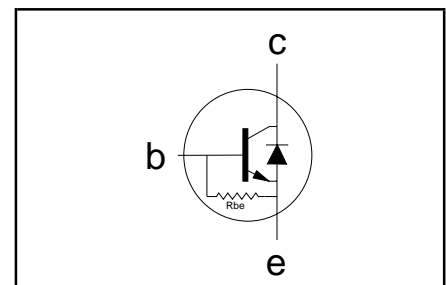

LIMITING VALUES

Limiting values in accordance with the Absolute Maximum Rating System (IEC 134)

SYMBOL	PARAMETER	CONDITIONS	MIN.	MAX.	UNIT
V_{CESM}	Collector-emitter voltage peak value	$V_{BE} = 0$ V	-	1500	V
V_{CEO}	Collector-emitter voltage (open base)		-	800	V
I_C	Collector current (DC)		-	5	A
I_{CM}	Collector current peak value		-	8	A
I_B	Base current (DC)		-	3	A
I_{BM}	Base current peak value		-	5	A
$-I_{BM}$	Reverse base current peak value ¹		-	4	A
P_{tot}	Total power dissipation	$T_{hs} \leq 25$ °C	-	32	W
T_{stg}	Storage temperature		-65	150	°C
T_j	Junction temperature		-	150	°C

THERMAL RESISTANCES

SYMBOL	PARAMETER	CONDITIONS	TYP.	MAX.	UNIT
$R_{th j-hs}$	Junction to heatsink	with heatsink compound	-	3.9	K/W
$R_{th j-a}$	Junction to ambient	in free air	55	-	K/W

¹ Turn-off current.

Silicon Diffused Power Transistor

BU4506DZ

ISOLATION LIMITING VALUE & CHARACTERISTIC $T_{hs} = 25\text{ °C}$ unless otherwise specified

SYMBOL	PARAMETER	CONDITIONS	MIN.	TYP.	MAX.	UNIT
V_{isol}	R.M.S. isolation voltage from all three terminals to external heatsink	$f = 50\text{-}60\text{ Hz}$; sinusoidal waveform; R.H. $\leq 65\%$; clean and dustfree	-		2500	V
C_{isol}	Capacitance from T2 to external heatsink	$f = 1\text{ MHz}$	-	10	-	pF

STATIC CHARACTERISTICS $T_{hs} = 25\text{ °C}$ unless otherwise specified

SYMBOL	PARAMETER	CONDITIONS	MIN.	TYP.	MAX.	UNIT
I_{CES}	Collector cut-off current ²	$V_{BE} = 0\text{ V}$; $V_{CE} = V_{CESMmax}$	-	-	1.0	mA
I_{CES}		$V_{BE} = 0\text{ V}$; $V_{CE} = V_{CESMmax}$ $T_j = 125\text{ °C}$	-	-	2.0	mA
BV_{EBO}	Emitter-base breakdown voltage	$I_B = 600\text{ mA}$	7.5	13.5	-	V
$V_{CEOsust}$	Collector-emitter sustaining voltage	$I_B = 0\text{ A}$; $I_C = 100\text{ mA}$; $L = 25\text{ mH}$	800	-	-	V
R_{be}	Base-emitter resistance	$V_{EB} = 6\text{ V}$	-	30	-	Ω
V_{CEsat}	Collector-emitter saturation voltage	$I_C = 3.0\text{ A}$; $I_B = 0.75\text{ A}$	-	-	3.0	V
V_{BEsat}	Base-emitter saturation voltage	$I_C = 3.0\text{ A}$; $I_B = 0.75\text{ A}$	0.8	0.89	0.98	V
h_{FE}	DC current gain	$I_C = 0.5\text{ A}$; $V_{CE} = 5\text{ V}$	-	7	-	
h_{FE}		$I_C = 3\text{ A}$; $V_{CE} = 5\text{ V}$	4.2	5.5	7.3	
V_F	Diode forward voltage	$I_F = 3.0\text{ A}$	-	1.55	1.9	V

DYNAMIC CHARACTERISTICS $T_{hs} = 25\text{ °C}$ unless otherwise specified

SYMBOL	PARAMETER	CONDITIONS	TYP.	MAX.	UNIT
t_s	Switching times (16kHz line deflection circuit)	$I_{Csat} = 3.0\text{ A}$; $I_{B1} = 0.6\text{ A}$; ($I_{B2} = -1.5\text{ A}$)			
t_f	Turn-off storage time		3.7	4.5	μs
t_f	Turn-off fall time		300	400	ns
V_{fr}	Anti-parallel diode forward recovery voltage	$I_F = 3\text{ A}$; $di_F/dt = 50\text{ A}/\mu\text{s}$	19	-	V
t_{fr}	Anti-parallel diode forward recovery time	$V_F = 5\text{ V}$	400	-	ns

² Measured with half sine-wave voltage (curve tracer).

Silicon Diffused Power Transistor

BU4506DZ

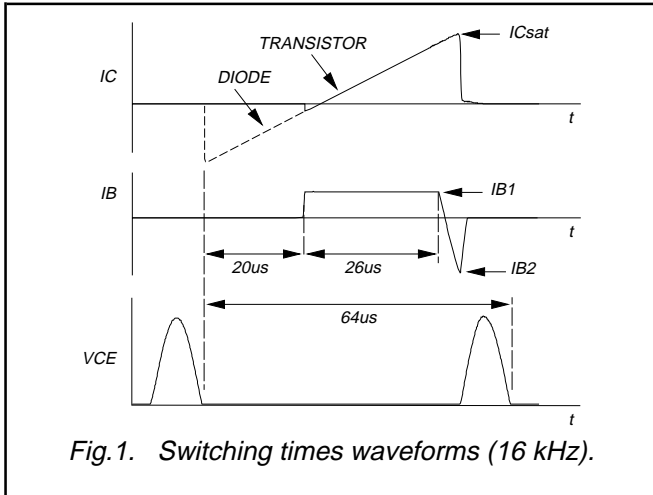

Fig.1. Switching times waveforms (16 kHz).

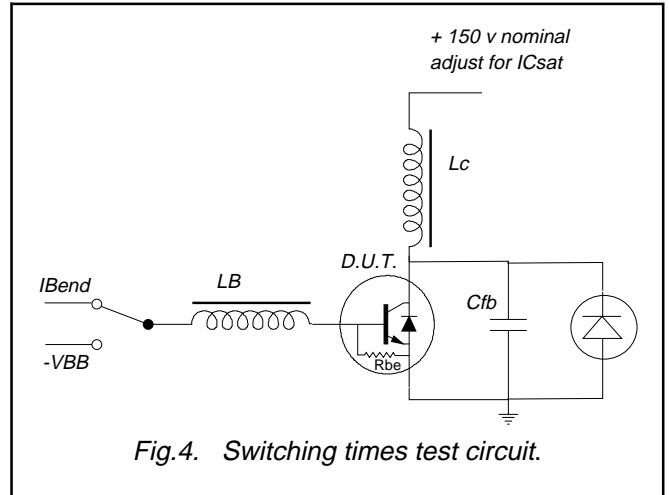

Fig.4. Switching times test circuit.

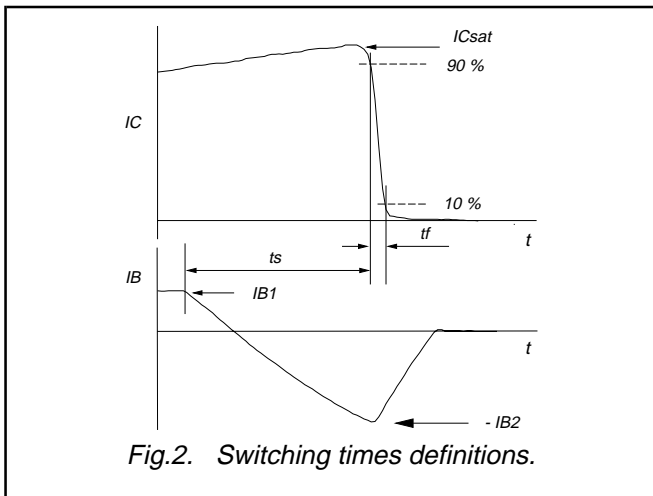

Fig.2. Switching times definitions.

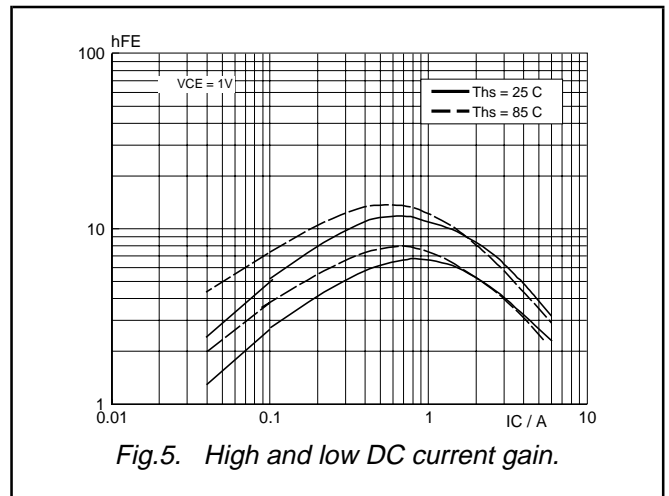

Fig.5. High and low DC current gain.

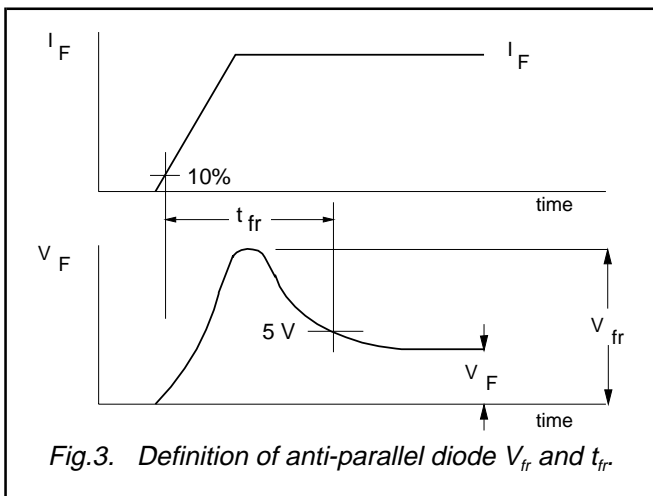

Fig.3. Definition of anti-parallel diode Vfr and tfr.

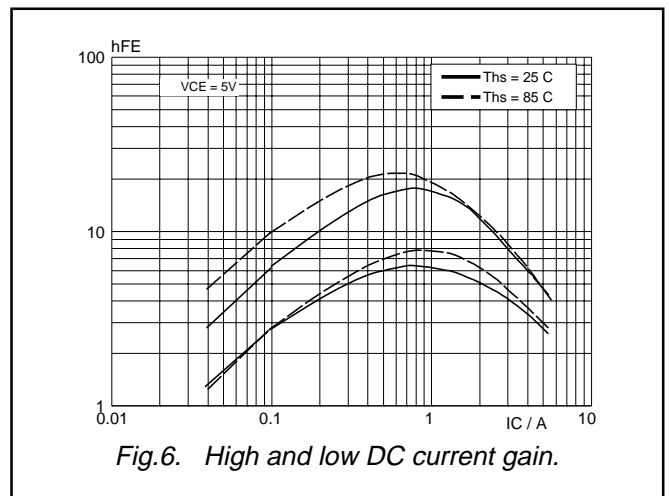
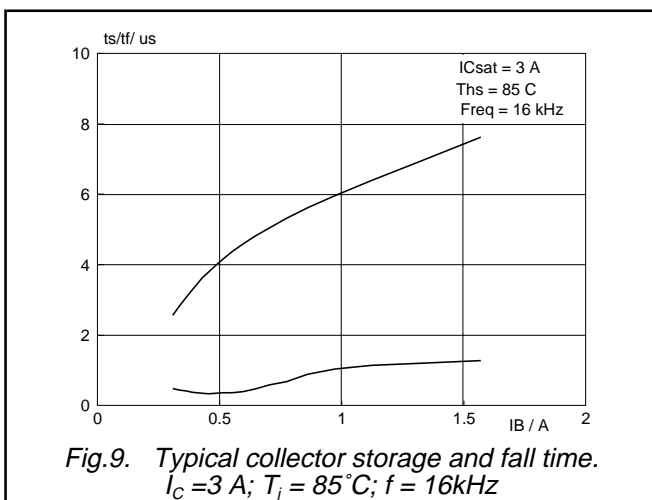
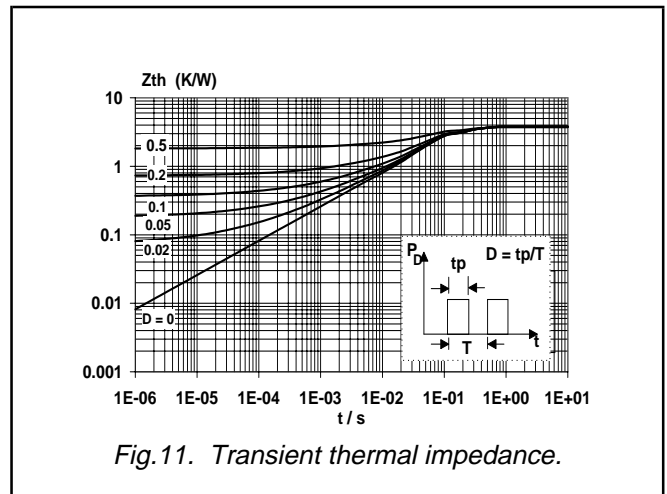
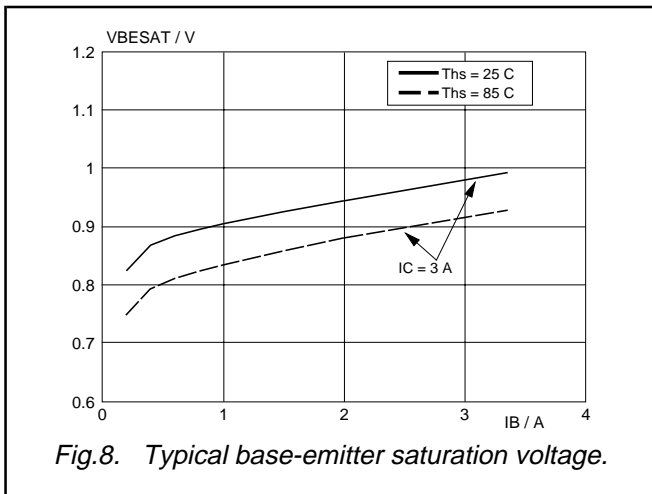
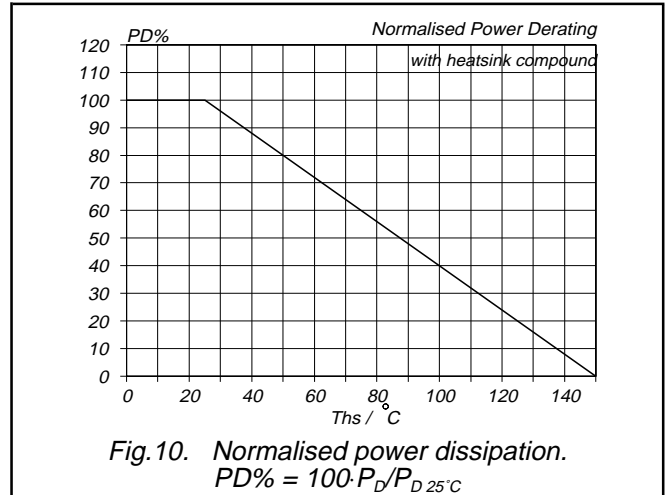
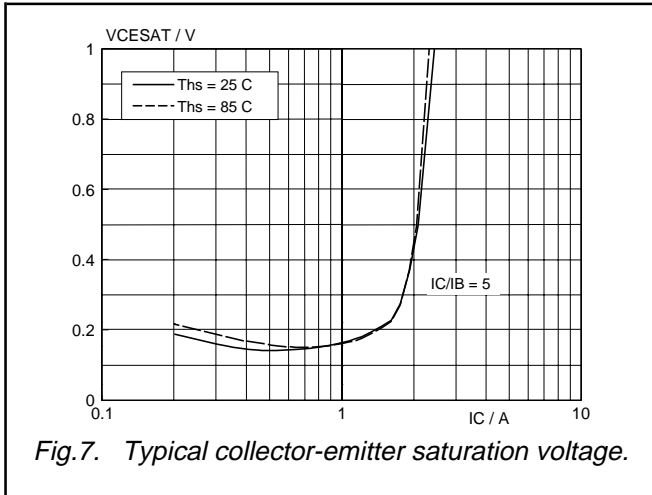

Fig.6. High and low DC current gain.

Silicon Diffused Power Transistor

BU4506DZ



Silicon Diffused Power Transistor

BU4506DZ

MECHANICAL DATA

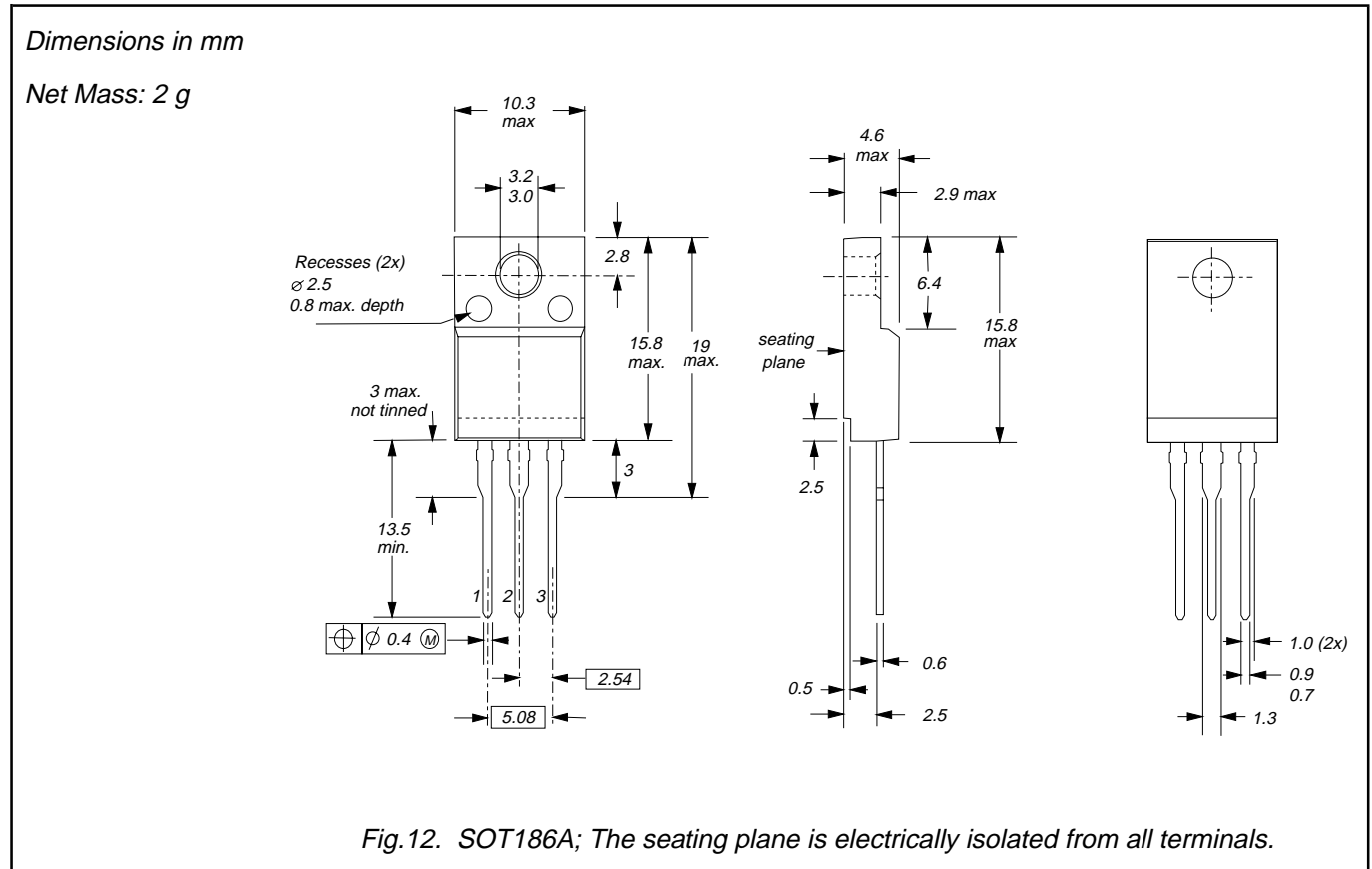

Notes

1. Refer to mounting instructions for F-pack envelopes.
2. Epoxy meets UL94 V0 at 1/8".

Silicon Diffused Power Transistor

BU4506DZ

DEFINITIONS

Data sheet status	
Objective specification	This data sheet contains target or goal specifications for product development.
Preliminary specification	This data sheet contains preliminary data; supplementary data may be published later.
Product specification	This data sheet contains final product specifications.
Limiting values	
Limiting values are given in accordance with the Absolute Maximum Rating System (IEC 134). Stress above one or more of the limiting values may cause permanent damage to the device. These are stress ratings only and operation of the device at these or at any other conditions above those given in the Characteristics sections of this specification is not implied. Exposure to limiting values for extended periods may affect device reliability.	
Application information	
Where application information is given, it is advisory and does not form part of the specification.	
© Philips Electronics N.V. 1999	
All rights are reserved. Reproduction in whole or in part is prohibited without the prior written consent of the copyright owner.	
The information presented in this document does not form part of any quotation or contract, it is believed to be accurate and reliable and may be changed without notice. No liability will be accepted by the publisher for any consequence of its use. Publication thereof does not convey nor imply any license under patent or other industrial or intellectual property rights.	

LIFE SUPPORT APPLICATIONS

These products are not designed for use in life support appliances, devices or systems where malfunction of these products can be reasonably expected to result in personal injury. Philips customers using or selling these products for use in such applications do so at their own risk and agree to fully indemnify Philips for any damages resulting from such improper use or sale.