

RECTIFIERS

High Efficiency, 30A Center-Tap

UES2604
UES2605
UES2606
UES2604HR2
UES2605HR2
UES2606HR2

2

FEATURES

- Very Low Forward Voltage (1.15V)
- Very Fast Recovery Times (50nSec)
- Low Profile Package
- High Surge Capability
- Low Thermal Resistance
- Mechanically Rugged
- Both Polarities Available

DESCRIPTION

The UES2604 series is specifically designed for operation in power switching circuits operating at frequencies of at least 20 KHz.

This series combines two high efficiency devices into one package, simplifying installation, reducing heat sink requirements and the need to purchase matched components.

ABSOLUTE MAXIMUM RATINGS

Peak Inverse Voltage, UES2604, UES2604HR2	200V
Peak Inverse Voltage, UES2605, UES2605HR2	300V
Peak Inverse Voltage, UES2606, UES2606HR2	400V
Maximum Average D.C. Output Current @ $T_C = 100^\circ\text{C}$	30A
Surge Current, 8.3mS	300A
Thermal Resistance, Junction to Case	1°C/W
Operating and Storage Temperature Range	-55°C to +150°C

POWER CYCLING

These devices possess the unique ability to pass many thousands of cycles of a stress test designed to evaluate the integrity of the bonding systems used in the construction of power rectifiers.

In this stress test, the case of the device is not heat sunk. Full rated forward current is supplied to force a case temperature increase at least 75°C, at which time, the current is removed and the case allowed to cool. The cycle is repeated a minimum of 5,000 times to simulate equipment being turned on and off. Extended power cycling tests demonstrate a product capability in excess of 25,000 cycles.

SWITCHING CHARACTERISTICS

The switching times of these ultra-fast rectifiers increase relatively little, with temperature or at different currents. Even in severe applications, such as catch diodes for switching regulators and output rectifiers for high frequency square wave inverters, these devices switch many times faster than the fastest associated transistors. Thus, the stresses on and powers dissipated in the switching transistors are substantially less than when using other rectifiers.

MECHANICAL SPECIFICATIONS

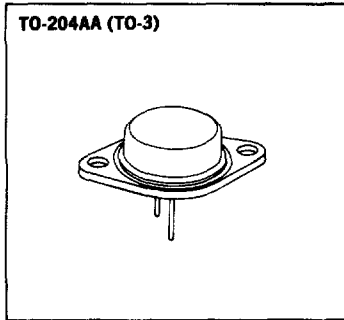
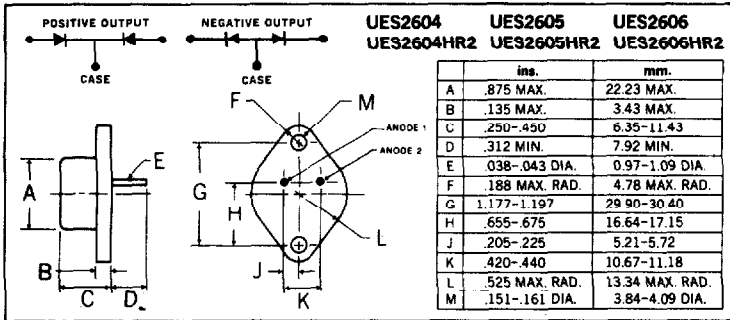

Notes:
Standard polarity is positive output.
For reverse polarity (negative output) add suffix "R", ie. UES2604R.

Microsemi Corp.
Watertown
The diode experts

ELECTRICAL SPECIFICATIONS, PER LEG

Type	PIV	Maximum Forward Voltage		Maximum Reverse Current		Maximum Reverse Recovery Time*
		$T_c = 25^\circ\text{C}$	$T_c = 125^\circ\text{C}$	$T_c = 25^\circ\text{C}$	$T_c = 125^\circ\text{C}$	
UES2604/2604HR2	200V	1.25V @ 15A $t_p = 300\mu\text{s}$	1.15V @ 15A $t_p = 300\mu\text{s}$	50 μA	10mA	50nS
UES2605/2605HR2	300V					
UES2606/2606HR2	400V					

*Measured in circuit $I_f = .5\text{A}$, $I_R = 1\text{A}$, $I_{RRC} = .25\text{A}$

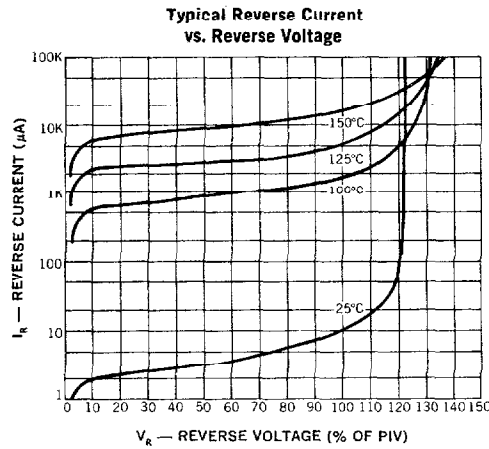
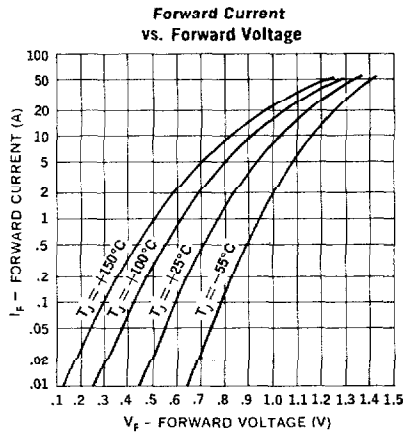
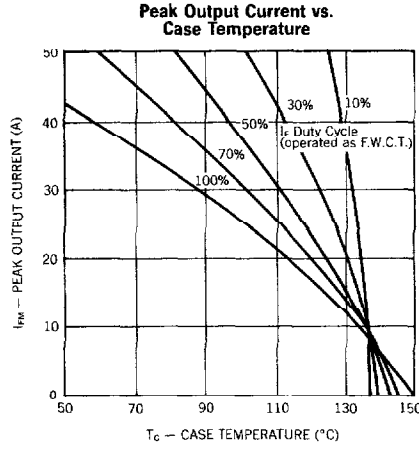
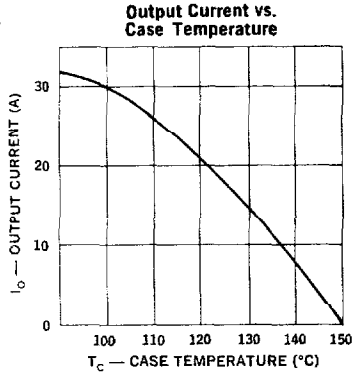

Maximum Forward Surge vs. Number of Cycles

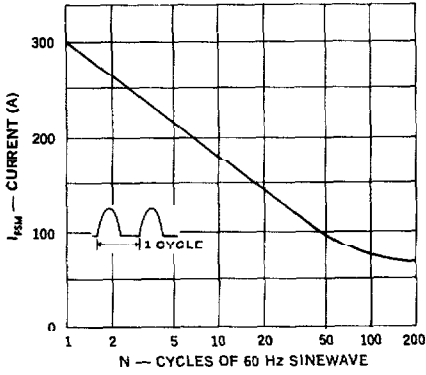

Thermal Impedance vs. Pulse Width

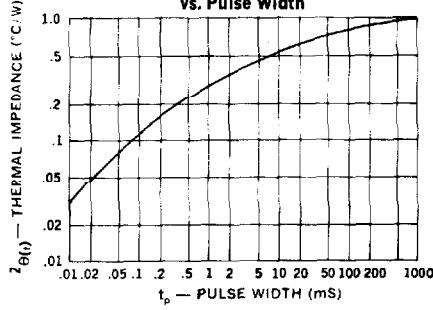

Reverse-Recovery Circuit

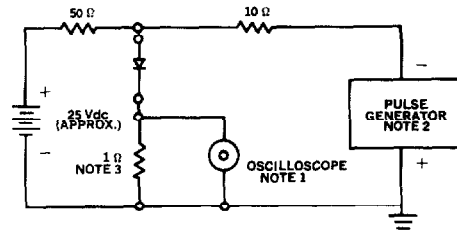

- NOTES:**
- Oscilloscope: Rise time ≤ 3ns; input impedance = 50Ω.
 - Pulse Generator: Rise time ≤ 8ns; source impedance 10Ω.
 - Current viewing resistor, non-inductive, coaxial recommended.

OPTIONAL HIGH RELIABILITY (HR2) SCREENING

The following tests are performed on 100% of the devices specified UES2604HR2, 5HR2, 6HR2.

SCREEN	MIL-STD-750 METHOD	CONDITIONS
1. High Temperature	1032	24 Hours @ T _A = 150°C
2. Temperature Cycle	1051	F, 20 Cycles, -55 to +150°C. No dwell required @ 25°C, t ≥ 10 min. @ extremes
3. Hermetic Seal a. Fine Leak b. Gross Leak	1071	H, Helium C, Liquid
4. Thermal Impedance		Sage Test
5. Interim Electrical Parameters	GO/NO GO	V _F and I _R @ 25°C
6. High Temperature Reverse Blocking	Similar to Method 1040	½ Sine Reverse, t = 48 Hours, T _C = 125°C, VRW _M = rating, F = 50-60 Hz, I _O = 0A
7. Final Electrical Parameters	GO/NO GO	V _F + I _R @ 25°C PDA = 10% (Final Electricals)