

Bias Resistor Transistors

PNP Silicon Surface Mount Transistors with Monolithic Bias Resistor Network

This new series of digital transistors is designed to replace a single device and its external resistor bias network. The BRT (Bias Resistor Transistor) contains a single transistor with a monolithic bias network consisting of two resistors; a series base resistor and a base-emitter resistor. The BRT eliminates these individual components by integrating them into a single device. The use of a BRT can reduce both system cost and board space. The device is housed in the SOT-23 package which is designed for low power surface mount applications.

- Simplifies Circuit Design
- Reduces Board Space
- Reduces Component Count
- The SOT-23 package can be soldered using wave or reflow. The modified gull-winged leads absorb thermal stress during soldering eliminating the possibility of damage to the die.
- Available in 8 mm embossed tape and reel. Use the Device Number to order the 7 inch/3000 unit reel. Replace “T1” with “T3” in the Device Number to order the 13 inch/10,000 unit reel.

MAXIMUM RATINGS ($T_A = 25^\circ\text{C}$ unless otherwise noted)

Rating	Symbol	Value	Unit
Collector-Base Voltage	V_{CBO}	50	Vdc
Collector-Emitter Voltage	V_{CEO}	50	Vdc
Collector Current	I_C	100	mAdc

THERMAL CHARACTERISTICS

Characteristic	Symbol	Max	Unit
Total Device Dissipation $T_A = 25^\circ\text{C}$ Derate above 25°C	P_D	246 (Note 1.) 400 (Note 2.) 1.5 (Note 1.) 2.0 (Note 2.)	mW $^\circ\text{C/W}$
Thermal Resistance – Junction-to-Ambient	$R_{\theta JA}$	508 (Note 1.) 311 (Note 2.)	$^\circ\text{C/W}$
Thermal Resistance – Junction-to-Lead	$R_{\theta JL}$	174 (Note 1.) 208 (Note 2.)	$^\circ\text{C/W}$
Junction and Storage Temperature Range	T_J, T_{stg}	-55 to +150	$^\circ\text{C}$

1. FR-4 @ Minimum Pad
2. FR-4 @ 1.0 x 1.0 inch Pad

MMUN2111LT1 SERIES

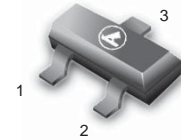

CASE 318, STYLE 6
SOT-23 (TO-236AB)

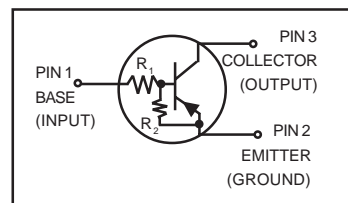

MARKING DIAGRAM

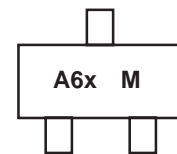

A6x = Device Marking
x = A - L (See Page 2)
M = Date Code

DEVICE MARKING INFORMATION

See specific marking information in the device marking table on page 2 of this data sheet.

MMUN2111LT1 Series

DEVICE MARKING AND RESISTOR VALUES

Device	Package	Marking	R1 (K)	R2 (K)	Shipping
MMUN2111LT1 MMUN2111LT3	SOT-23	A6A	10	10	3000/Tape & Reel 10,000/Tape & Reel
MMUN2112LT1 MMUN2112LT3	SOT-23	A6B	22	22	3000/Tape & Reel 10,000/Tape & Reel
MMUN2113LT1 MMUN2113LT3	SOT-23	A6C	47	47	3000/Tape & Reel 10,000/Tape & Reel
MMUN2114LT1 MMUN2114LT3	SOT-23	A6D	10	47	3000/Tape & Reel 10,000/Tape & Reel
MMUN2115LT1 (Note 3.) MMUN2115LT3	SOT-23	A6E	10	∞	3000/Tape & Reel 10,000/Tape & Reel
MMUN2116LT1 (Note 3.) MMUN2116LT3	SOT-23	A6F	4.7	∞	3000/Tape & Reel 10,000/Tape & Reel
MMUN2130LT1 (Note 3.) MMUN2130LT3	SOT-23	A6G	1.0	1.0	3000/Tape & Reel 10,000/Tape & Reel
MMUN2131LT1 (Note 3.) MMUN2131LT3	SOT-23	A6H	2.2	2.2	3000/Tape & Reel 10,000/Tape & Reel
MMUN2132LT1 (Note 3.) MMUN2132LT3	SOT-23	A6J	4.7	4.7	3000/Tape & Reel 10,000/Tape & Reel
MMUN2133LT1 (Note 3.) MMUN2133LT3	SOT-23	A6K	4.7	47	3000/Tape & Reel 10,000/Tape & Reel
MMUN2134LT1 (Note 3.) MMUN2134LT3	SOT-23	A6L	22	47	3000/Tape & Reel 10,000/Tape & Reel

ELECTRICAL CHARACTERISTICS (T_A = 25°C unless otherwise noted)

Characteristic	Symbol	Min	Typ	Max	Unit
----------------	--------	-----	-----	-----	------

OFF CHARACTERISTICS

Collector-Base Cutoff Current (V _{CB} = 50 V, I _E = 0)	I _{CBO}	–	–	100	nAdc
Collector-Emitter Cutoff Current (V _{CE} = 50 V, I _B = 0)	I _{CEO}	–	–	500	nAdc
Emitter-Base Cutoff Current (V _{EB} = 6.0 V, I _C = 0)	I _{EBO}	–	–	0.5	mAdc
	MMUN2111LT1	–	–	0.2	
	MMUN2112LT1	–	–	0.1	
	MMUN2113LT1	–	–	0.2	
	MMUN2114LT1	–	–	0.9	
	MMUN2115LT1	–	–	1.9	
	MMUN2116LT1	–	–	4.3	
	MMUN2130LT1	–	–	2.3	
	MMUN2131LT1	–	–	1.5	
	MMUN2132LT1	–	–	0.18	
	MMUN2133LT1	–	–	0.13	
	MMUN2134LT1	–	–		
Collector-Base Breakdown Voltage (I _C = 10 μA, I _E = 0)	V _{(BR)CBO}	50	–	–	Vdc
Collector-Emitter Breakdown Voltage (Note 4.) (I _C = 2.0 mA, I _B = 0)	V _{(BR)CEO}	50	–	–	Vdc

3. New devices. Updated curves to follow in subsequent data sheets.

4. Pulse Test: Pulse Width < 300 μs, Duty Cycle < 2.0%

MMUN2111LT1 Series

ELECTRICAL CHARACTERISTICS ($T_A = 25^\circ\text{C}$ unless otherwise noted) (Continued)

Characteristic	Symbol	Min	Typ	Max	Unit	
ON CHARACTERISTICS (Note 5.)						
DC Current Gain ($V_{CE} = 10\text{ V}$, $I_C = 5.0\text{ mA}$)	MMUN2111LT1 MMUN2112LT1 MMUN2113LT1 MMUN2114LT1 MMUN2115LT1 MMUN2116LT1 MMUN2130LT1 MMUN2131LT1 MMUN2132LT1 MMUN2133LT1 MMUN2134LT1	h_{FE}	35 60 80 80 160 160 3.0 8.0 15 80 80	60 100 140 140 250 250 5.0 15 27 140 130	– – – – – – – – – – –	
Collector-Emitter Saturation Voltage ($I_C = 10\text{ mA}$, $I_E = 0.3\text{ mA}$) ($I_C = 10\text{ mA}$, $I_B = 5\text{ mA}$) MMUN2130LT1/MMUN2131LT1 ($I_C = 10\text{ mA}$, $I_B = 1\text{ mA}$) MMUN2115LT1/MMUN2116LT1/ MMUN2132LT1/MMUN2133LT1/MMUN2134LT1		$V_{CE(sat)}$	–	–	0.25	Vdc
Output Voltage (on) ($V_{CC} = 5.0\text{ V}$, $V_B = 2.5\text{ V}$, $R_L = 1.0\text{ k}\Omega$) ($V_{CC} = 5.0\text{ V}$, $V_B = 3.5\text{ V}$, $R_L = 1.0\text{ k}\Omega$)	MMUN2111LT1 MMUN2112LT1 MMUN2114LT1 MMUN2115LT1 MMUN2116LT1 MMUN2130LT1 MMUN2131LT1 MMUN2132LT1 MMUN2133LT1 MMUN2134LT1 MMUN2113LT1	V_{OL}	– – – – – – – – – – –	– – – – – – – – – – –	0.2 0.2 0.2 0.2 0.2 0.2 0.2 0.2 0.2 0.2 0.2	Vdc
Output Voltage (off) ($V_{CC} = 5.0\text{ V}$, $V_B = 0.5\text{ V}$, $R_L = 1.0\text{ k}\Omega$) ($V_{CC} = 5.0\text{ V}$, $V_B = 0.25\text{ V}$, $R_L = 1.0\text{ k}\Omega$) ($V_{CC} = 5.0\text{ V}$, $V_B = 0.050\text{ V}$, $R_L = 1.0\text{ k}\Omega$)	MMUN2115LT1 MMUN2116LT1 MMUN2131LT1 MMUN2132LT1 MMUN2130LT1	V_{OH}	4.9	–	–	Vdc
Input Resistor	MMUN2111LT1 MMUN2112LT1 MMUN2113LT1 MMUN2114LT1 MMUN2115LT1 MMUN2116LT1 MMUN2130LT1 MMUN2131LT1 MMUN2132LT1 MMUN2133LT1 MMUN2134LT1	R_1	7.0 15.4 32.9 7.0 7.0 3.3 0.7 1.5 3.3 3.3 15.4	10 22 47 10 10 4.7 1.0 2.2 4.7 4.7 22	13 28.6 61.1 13 13 6.1 1.3 2.9 6.1 6.1 28.6	k Ω
Resistor Ratio	MMUN2111LT1/MMUN2112LT1/MMUN2113LT1 MMUN2114LT1 MMUN2115LT1/MMUN2116LT1 MMUN2130LT1/MMUN2131LT1/MMUN2132LT1 MMUN2133LT1	R_1/R_2	0.8 0.17 – 0.8 0.055	1.0 0.21 – 1.0 0.1	1.2 0.25 – 1.2 0.185	

5. Pulse Test: Pulse Width < 300 μs , Duty Cycle < 2.0%

TYPICAL ELECTRICAL CHARACTERISTICS
MMUN2111LT1

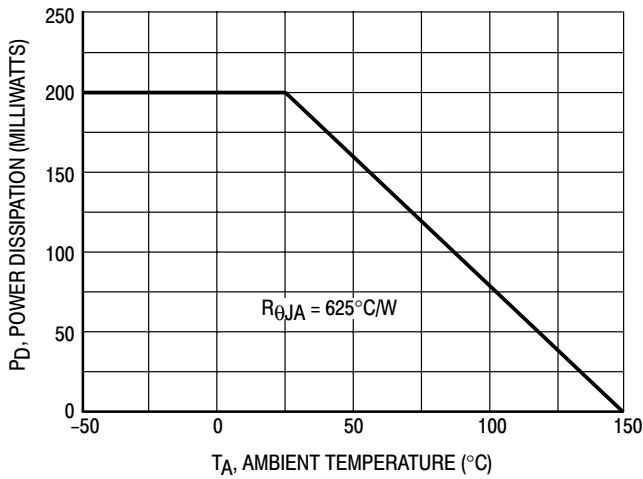

Figure 1. Derating Curve

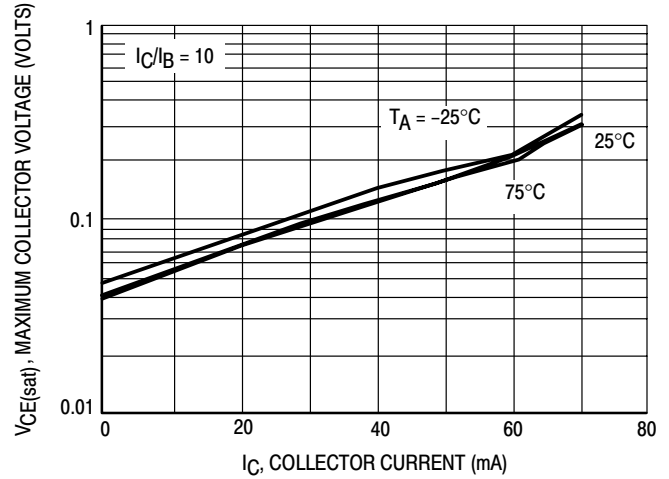

Figure 2. $V_{CE(sat)}$ versus I_C

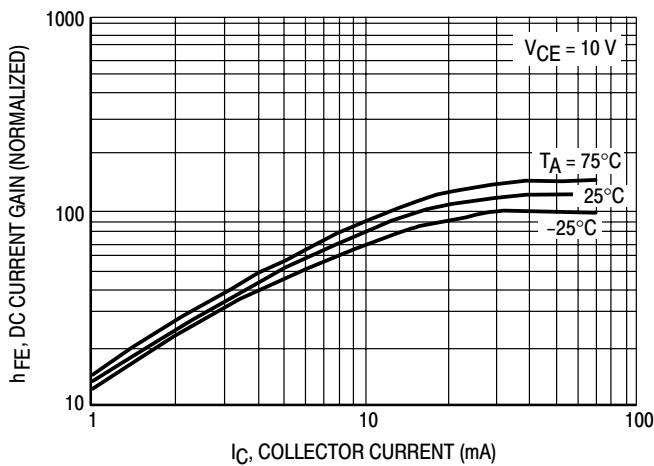

Figure 3. DC Current Gain

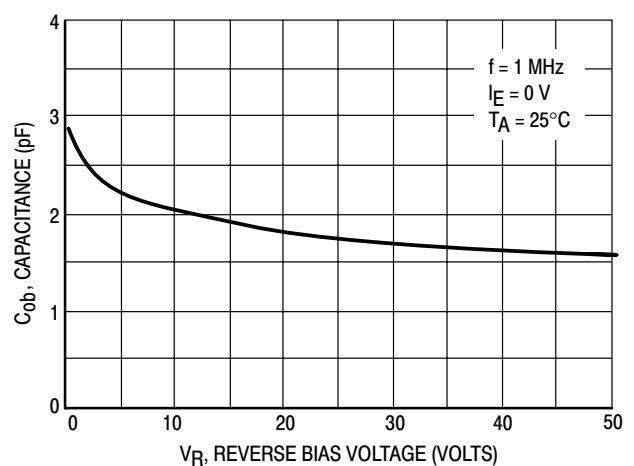

Figure 4. Output Capacitance

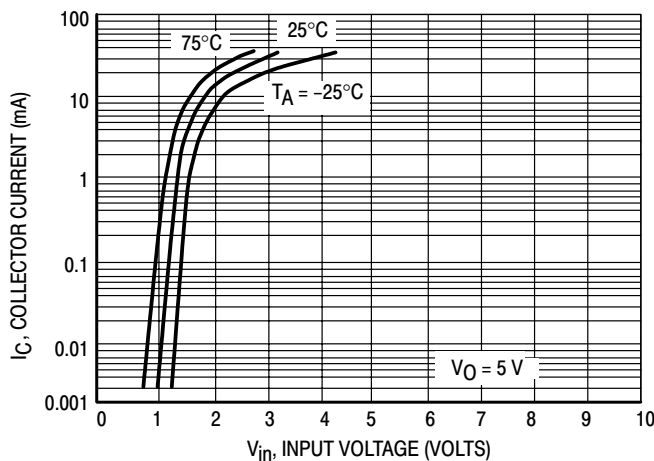

Figure 5. Output Current versus Input Voltage

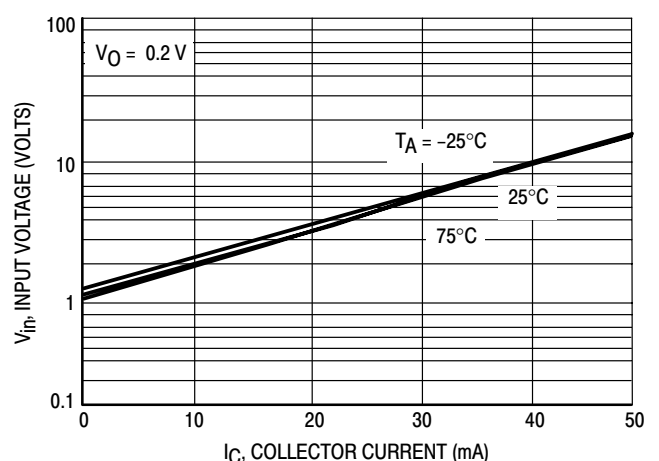

Figure 6. Input Voltage versus Output Current

MMUN2111LT1 Series

TYPICAL ELECTRICAL CHARACTERISTICS
MMUN2112LT1

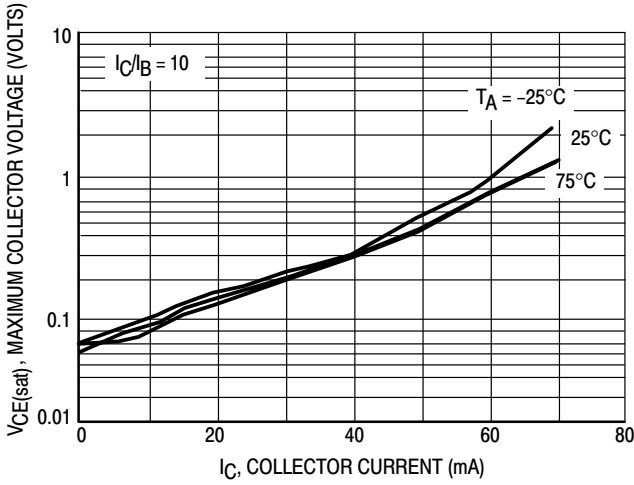

Figure 7. $V_{CE(sat)}$ versus I_C

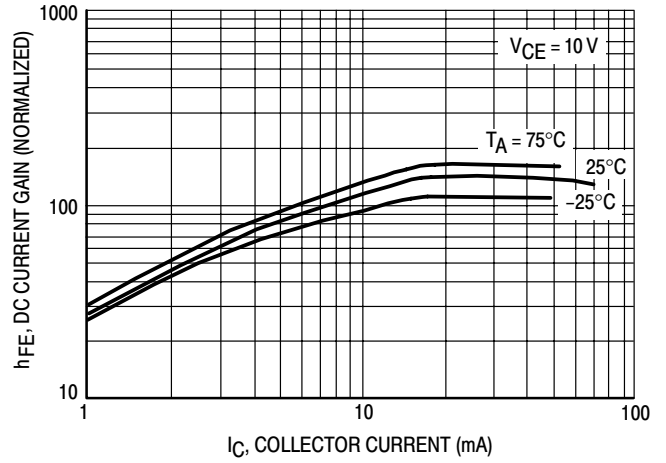

Figure 8. DC Current Gain

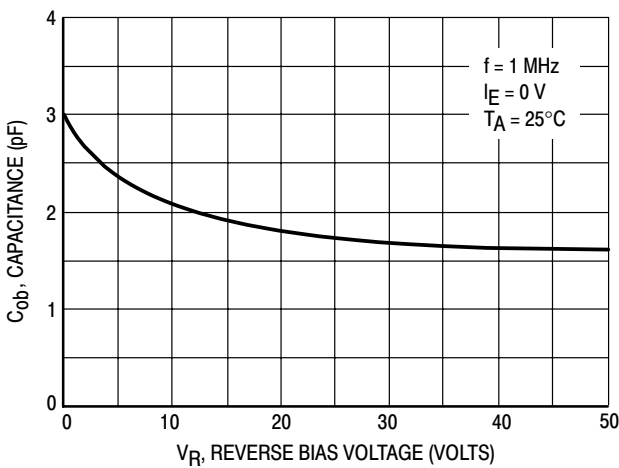

Figure 9. Output Capacitance

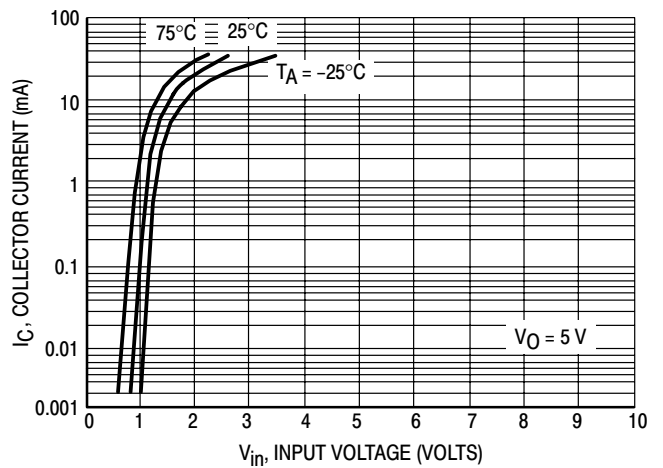

Figure 10. Output Current versus Input Voltage

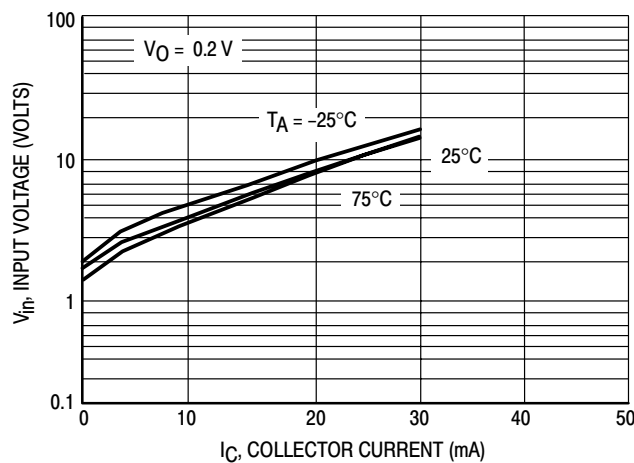

Figure 11. Input Voltage versus Output Current

MMUN2111LT1 Series

TYPICAL ELECTRICAL CHARACTERISTICS
MMUN2113LT1

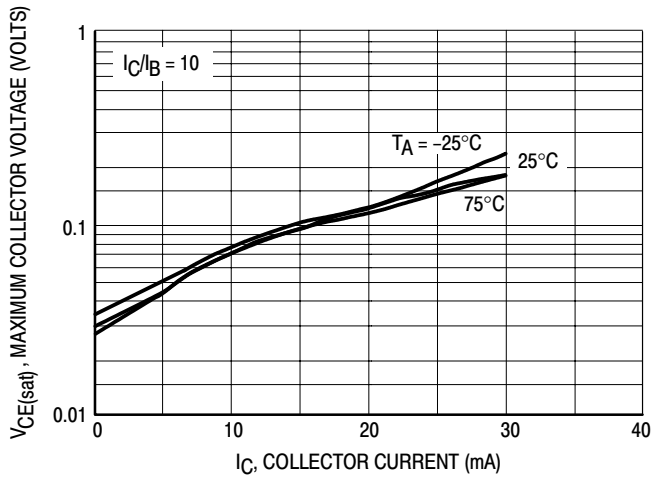

Figure 12. $V_{CE(sat)}$ versus I_C

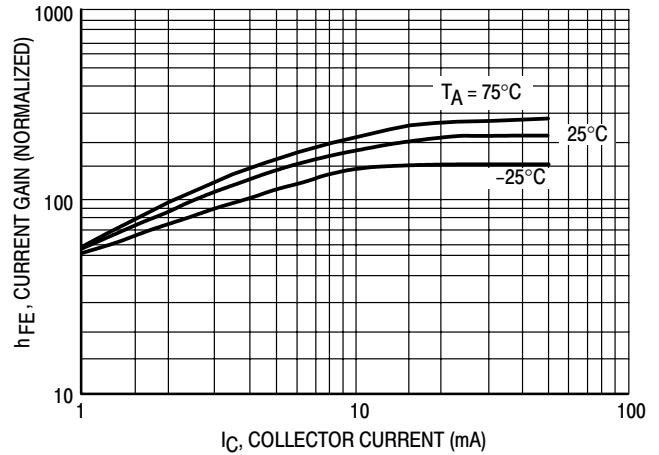

Figure 13. DC Current Gain

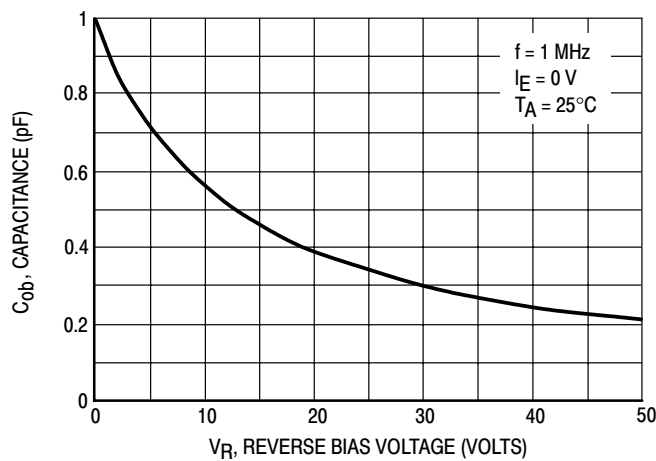

Figure 14. Output Capacitance

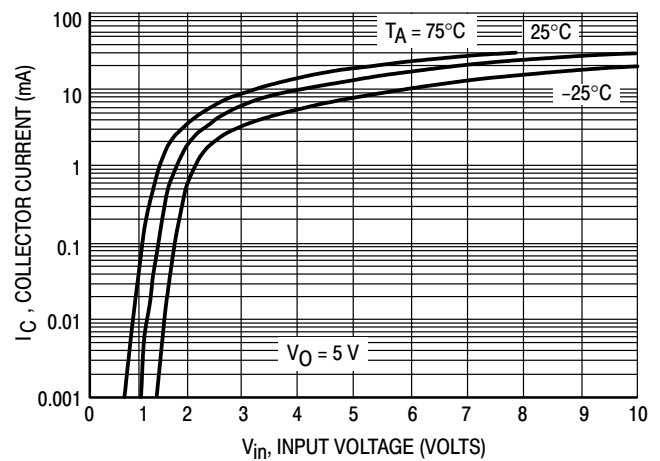

Figure 15. Output Current versus Input Voltage

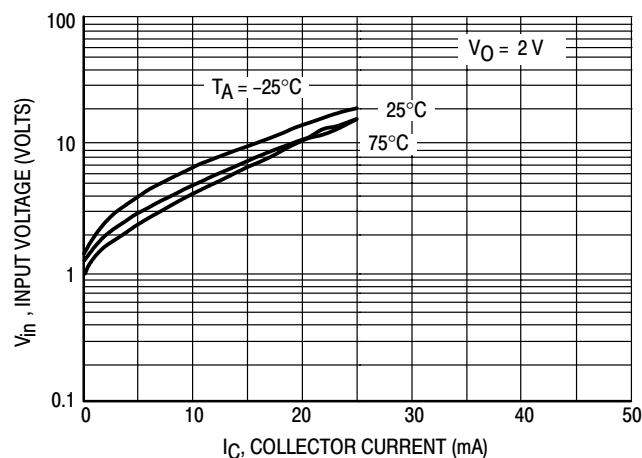

Figure 16. Input Voltage versus Output Current

MMUN2111LT1 Series

TYPICAL ELECTRICAL CHARACTERISTICS
MMUN2114LT1

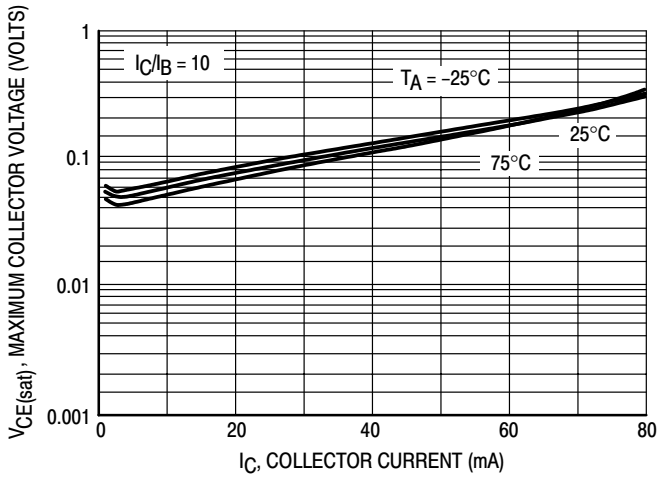

Figure 17. $V_{CE(sat)}$ versus I_C

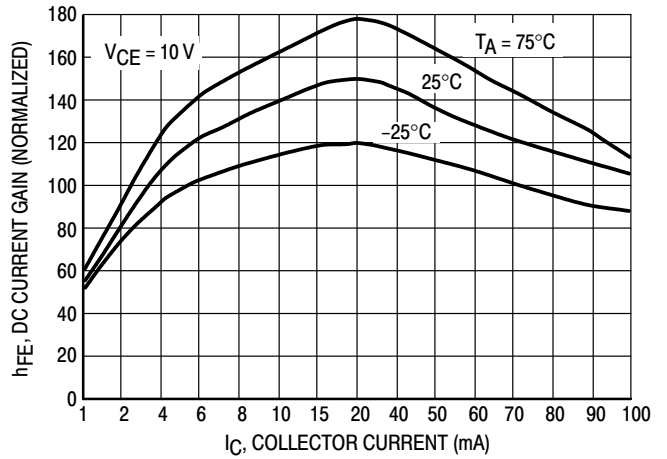

Figure 18. DC Current Gain

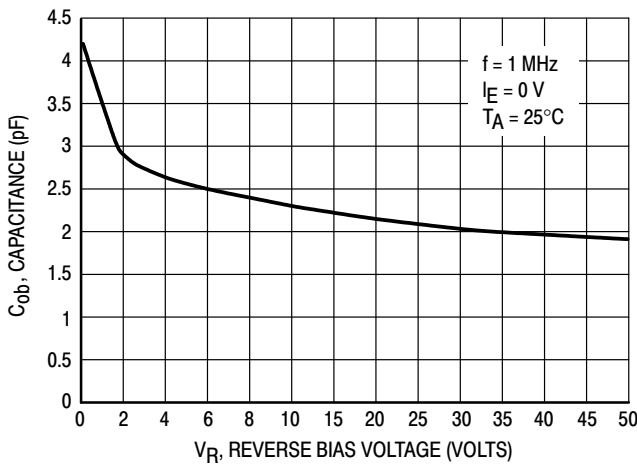

Figure 19. Output Capacitance

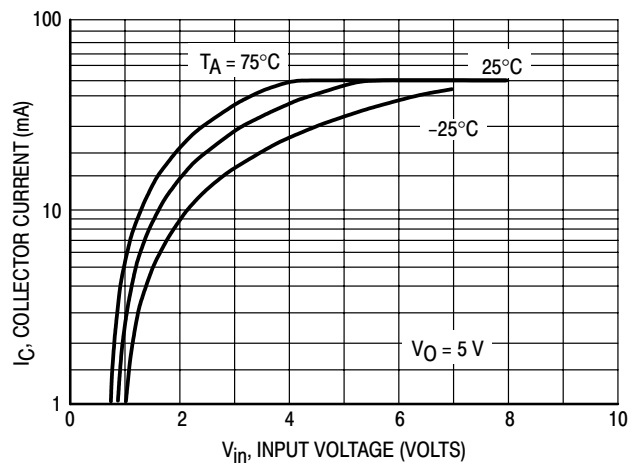

Figure 20. Output Current versus Input Voltage

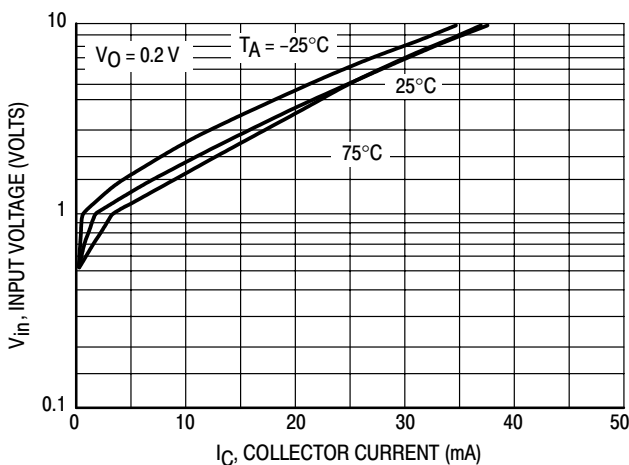

Figure 21. Input Voltage versus Output Current

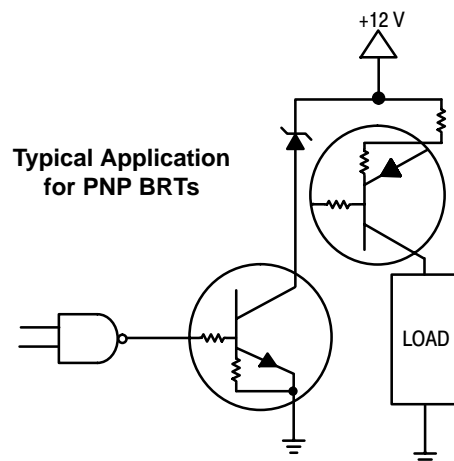

Figure 22. Inexpensive, Unregulated Current Source