

PNP Silicon Switching Transistor Array

- High DC current gain: 0.1mA to 100mA
- Low collector-emitter saturation voltage
- Two (galvanic) internal isolated Transistors with good matching in one package
- Complementary type: SMBT3904S (NPN)

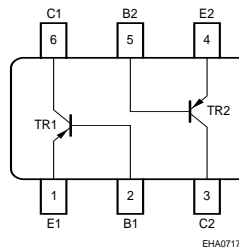
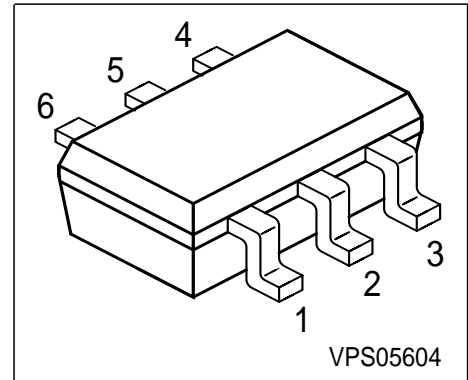

Type	Marking	Pin Configuration					Package	
SMBT3906S	s2A	1=E1	2=B1	3=C2	4=E2	5=B2	6=C1	SOT363

Maximum Ratings

Parameter	Symbol	Value	Unit
Collector-emitter voltage	V_{CEO}	40	V
Collector-base voltage	V_{CBO}	40	
Emitter-base voltage	V_{EBO}	5	
DC collector current	I_C	200	mA
Total power dissipation, $T_S = 115\text{ °C}$	P_{tot}	250	mW
Junction temperature	T_j	150	°C
Storage temperature	T_{stg}	-65 ... 150	

Thermal Resistance

Junction - soldering point ¹⁾	R_{thJS}	≤140	K/W
--	------------	------	-----

¹⁾For calculation of R_{thJA} please refer to Application Note Thermal Resistance

Electrical Characteristics at $T_A = 25^\circ\text{C}$, unless otherwise specified.

Parameter	Symbol	Values			Unit
		min.	typ.	max.	
DC Characteristics					
Collector-emitter breakdown voltage $I_C = 1\text{ mA}, I_B = 0$	$V_{(BR)CEO}$	40	-	-	V
Collector-base breakdown voltage $I_C = 10\text{ }\mu\text{A}, I_E = 0$	$V_{(BR)CBO}$	40	-	-	
Emitter-base breakdown voltage $I_E = 10\text{ }\mu\text{A}, I_C = 0$	$V_{(BR)EBO}$	5	-	-	
Collector cutoff current $V_{CB} = 30\text{ V}, I_E = 0$	I_{CBO}	-	-	50	nA
DC current gain 1) $I_C = 100\text{ }\mu\text{A}, V_{CE} = 1\text{ V}$ $I_C = 1\text{ mA}, V_{CE} = 1\text{ V}$ $I_C = 10\text{ mA}, V_{CE} = 1\text{ V}$ $I_C = 50\text{ mA}, V_{CE} = 1\text{ V}$ $I_C = 100\text{ mA}, V_{CE} = 1\text{ V}$	h_{FE}	60 80 100 60 30	- - - - -	- - 300 - -	-
Collector-emitter saturation voltage1) $I_C = 10\text{ mA}, I_B = 1\text{ mA}$ $I_C = 50\text{ mA}, I_B = 5\text{ mA}$	V_{CEsat}	- -	- -	0.25 0.4	V
Base-emitter saturation voltage 1) $I_C = 10\text{ mA}, I_B = 1\text{ mA}$ $I_C = 50\text{ mA}, I_B = 5\text{ mA}$	V_{BEsat}	0.65 -	- -	0.85 0.95	

1) Pulse test: $t < 300\text{ }\mu\text{s}$; $D < 2\%$

Electrical Characteristics at $T_A = 25^\circ\text{C}$, unless otherwise specified.

Parameter	Symbol	Values			Unit
		min.	typ.	max.	
AC Characteristics					
Transition frequency $I_C = 10 \text{ mA}, V_{CE} = 5 \text{ V}, f = 100 \text{ MHz}$	f_T	250	-	-	MHz
Collector-base capacitance $V_{CB} = 10 \text{ V}, f = 1 \text{ MHz}$	C_{cb}	-	-	4.5	pF
Emitter-base capacitance $V_{EB} = 0.5 \text{ V}, f = 1 \text{ MHz}$	C_{eb}	-	-	10	
Short-circuit input impedance $I_C = 2 \text{ mA}, V_{CE} = 5 \text{ V}, f = 1 \text{ kHz}$	h_{11e}	2	-	12	k Ω
Open-circuit reverse voltage transf.ratio $I_C = 2 \text{ mA}, V_{CE} = 5 \text{ V}, f = 1 \text{ kHz}$	h_{12e}	0.1	-	10	10^{-4}
Short-circuit forward current transf.ratio $I_C = 2 \text{ mA}, V_{CE} = 5 \text{ V}, f = 1 \text{ kHz}$	h_{21e}	100	-	400	-
Open-circuit output admittance $I_C = 2 \text{ mA}, V_{CE} = 5 \text{ V}, f = 1 \text{ kHz}$	h_{22e}	3	-	60	μS
Noise figure $I_C = 100 \mu\text{A}, V_{CE} = 5 \text{ V}, R_S = 1 \text{ k}\Omega,$ $f = 1 \text{ kHz}, \Delta f = 200 \text{ Hz}$	F	-	-	4	dB
Delay time $V_{CC} = 3 \text{ V}, I_C = 10 \text{ mA}, I_{B1} = 1 \text{ mA},$ $V_{BE(\text{off})} = 0.5 \text{ V}$	t_d	-	-	35	ns
Rise time $V_{CC} = 3 \text{ V}, I_C = 10 \text{ mA}, I_{B1} = 1 \text{ mA},$ $V_{BE(\text{off})} = 0.5 \text{ V}$	t_r	-	-	35	
Storage time $V_{CC} = 3 \text{ V}, I_C = 10 \text{ mA}, I_{B1}=I_{B2} = 1 \text{ mA}$	t_{stg}	-	-	225	
Fall time $V_{CC} = 3 \text{ V}, I_C = 10 \text{ mA}, I_{B1}=I_{B2} = 1 \text{ mA}$	t_f	-	-	75	

Test circuit

Delay and rise time

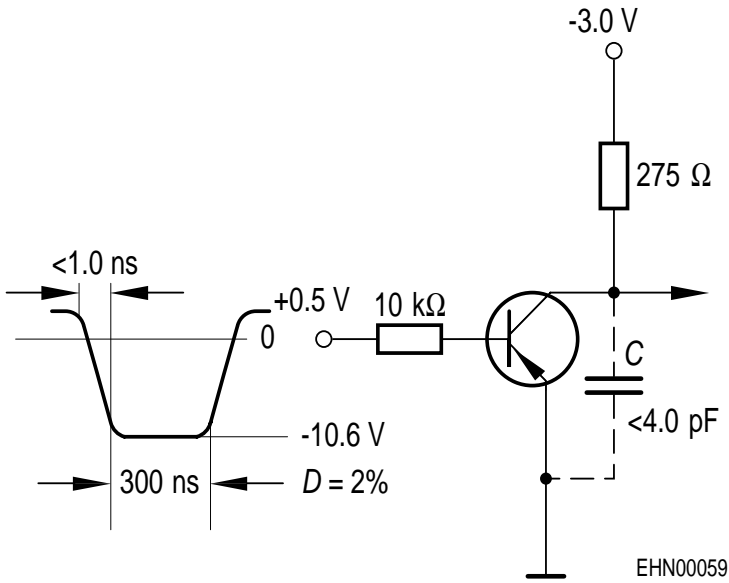

Storage time and fall time

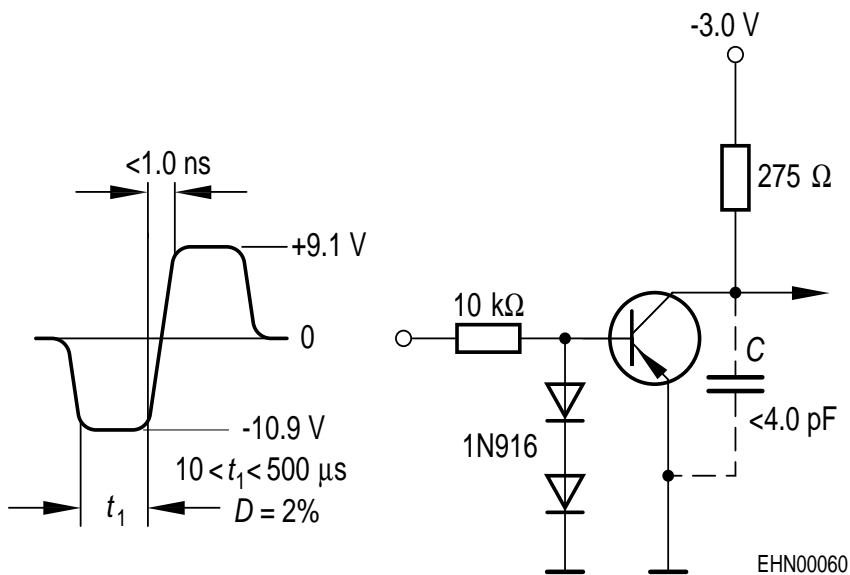

Total power dissipation $P_{tot} = f(T_S)$

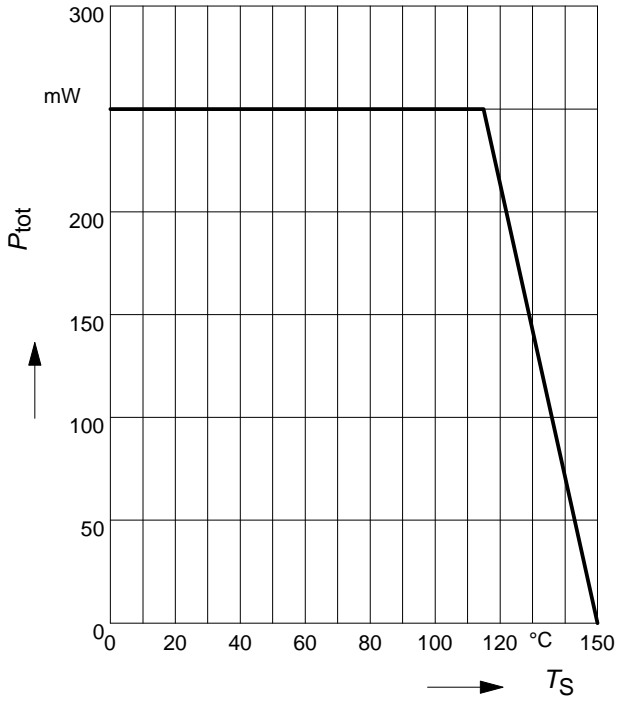

Permissible Pulse Load $R_{thJS} = f(t_p)$

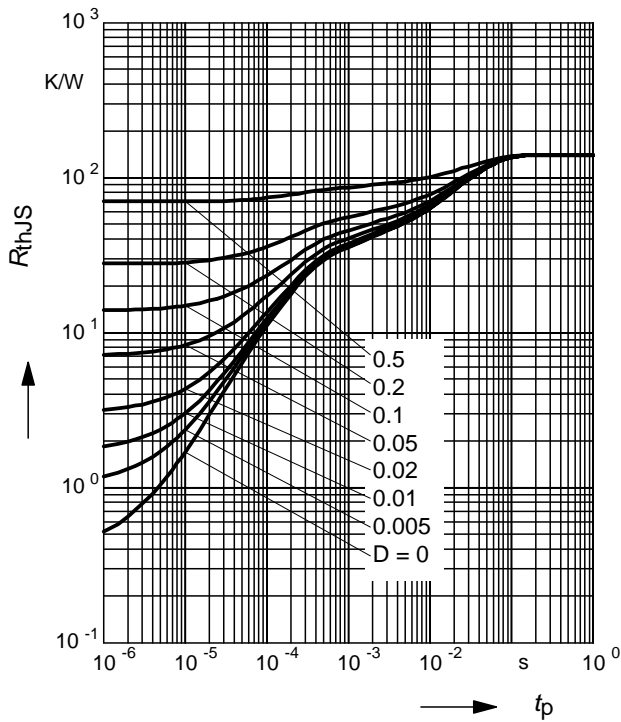

Permissible Pulse Load

$P_{totmax} / P_{totDC} = f(t_p)$

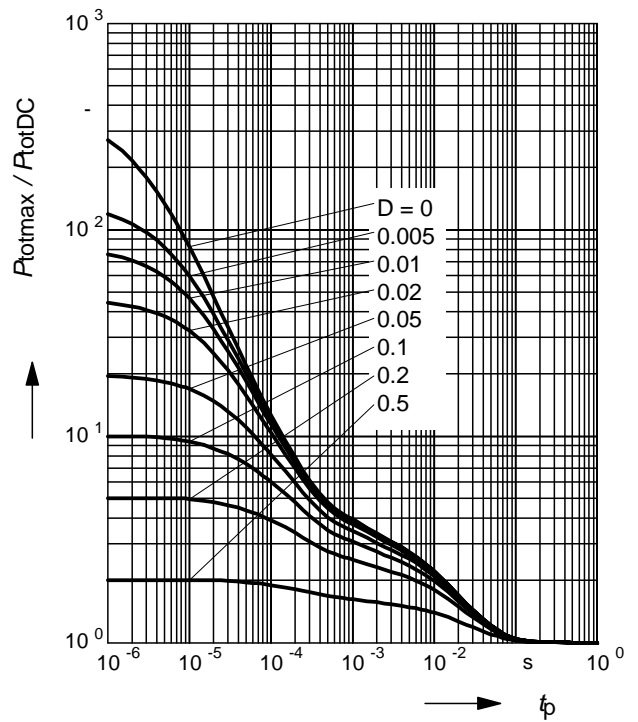

DC current gain $h_{FE} = f(I_C)$

$V_{CE} = 10V$, normalized

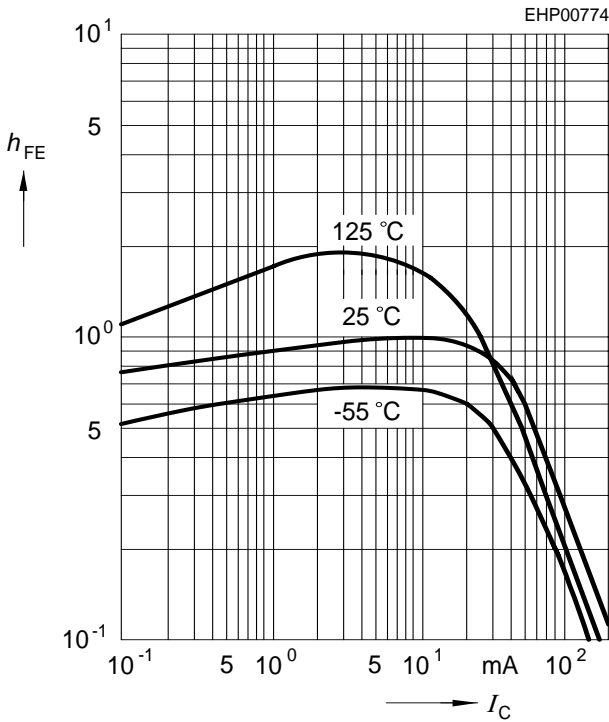

Saturation voltage $I_C = f(V_{BEsat}, V_{CEsat})$

$h_{FE} = 10$

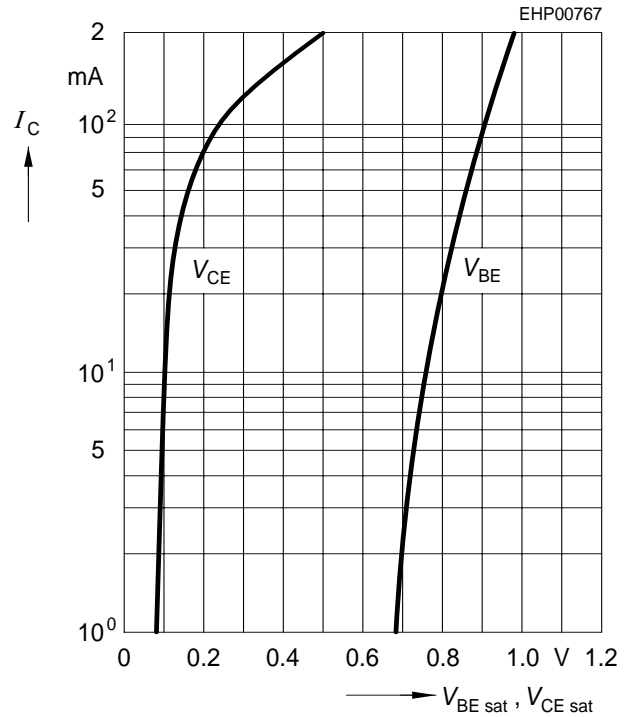

Short-circuit forward current transfer ratio $h_{21e} = f(I_C)$

$V_{CE} = 10V$, $f = 1MHz$

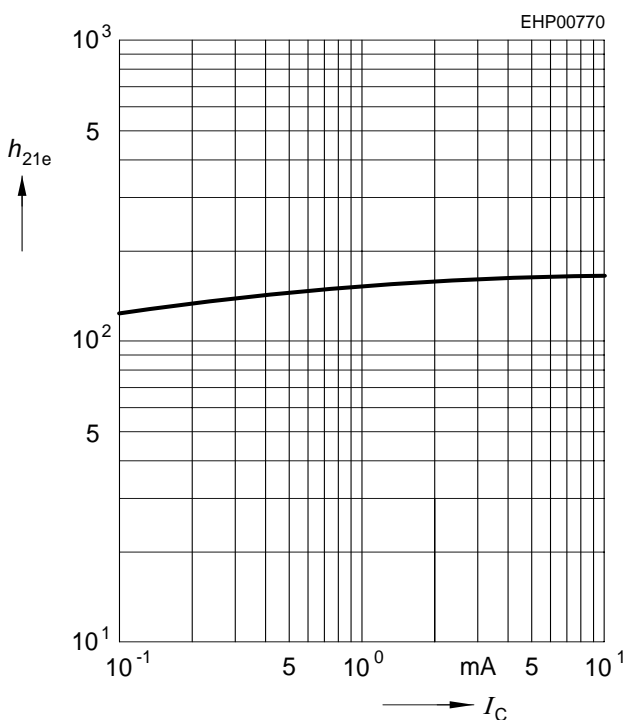

Open-circuit output admittance $h_{22e} = f(I_C)$

$h_{22e} = f(I_C)$

$V_{CE} = 10V$, $f = 1MHz$

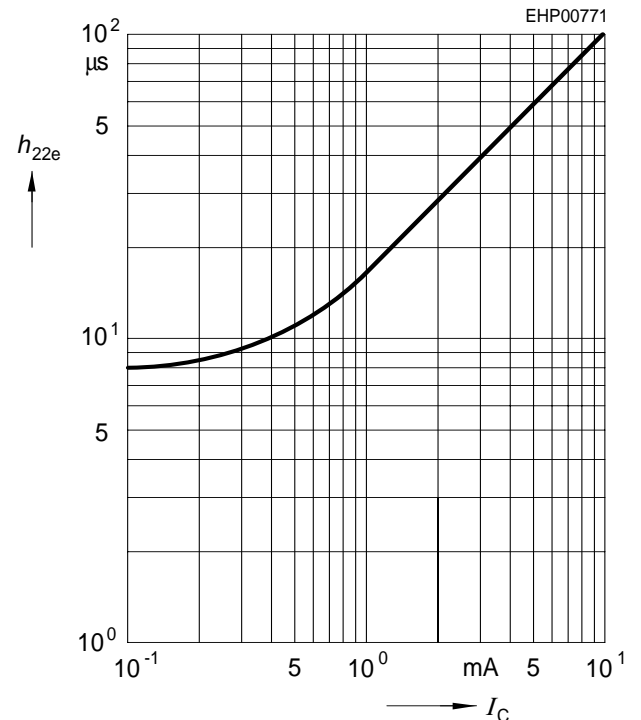

Delay time $t_d = f(I_C)$

Rise time $t_r = f(I_C)$

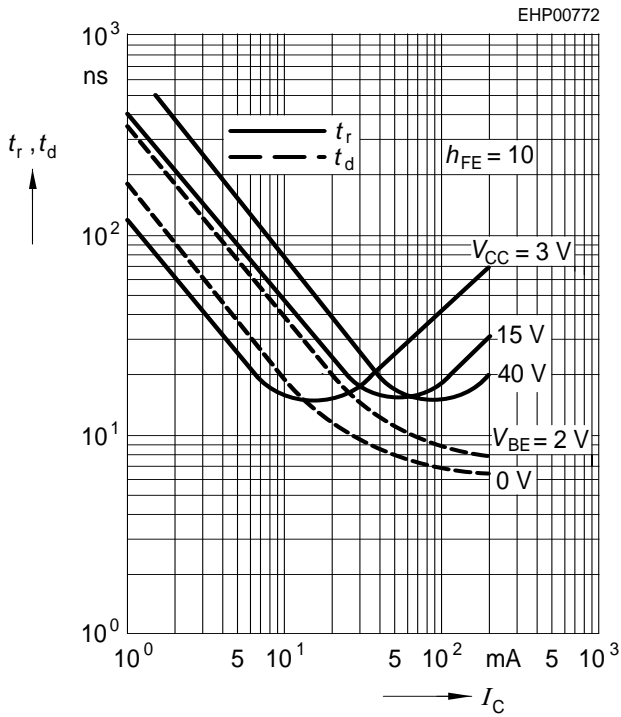

Storage time $t_{stg} = f(I_C)$

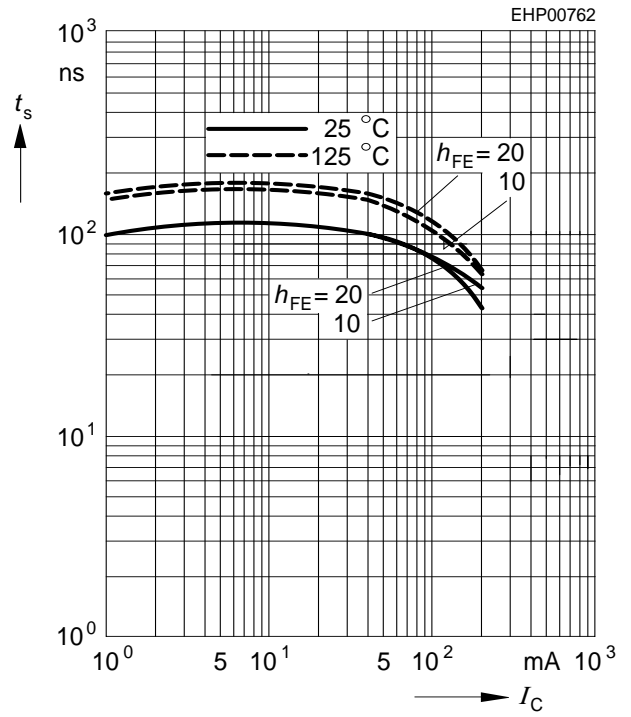

Fall time $t_f = f(I_C)$

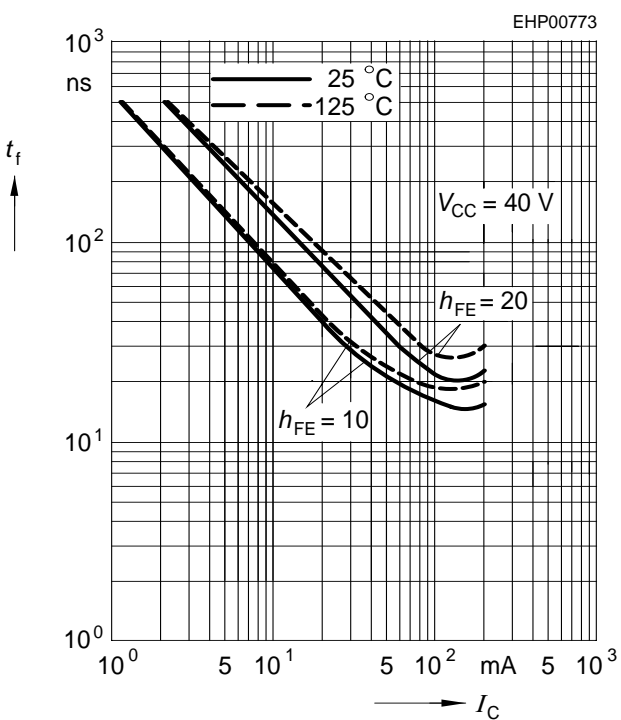

Rise time $t_r = f(I_C)$

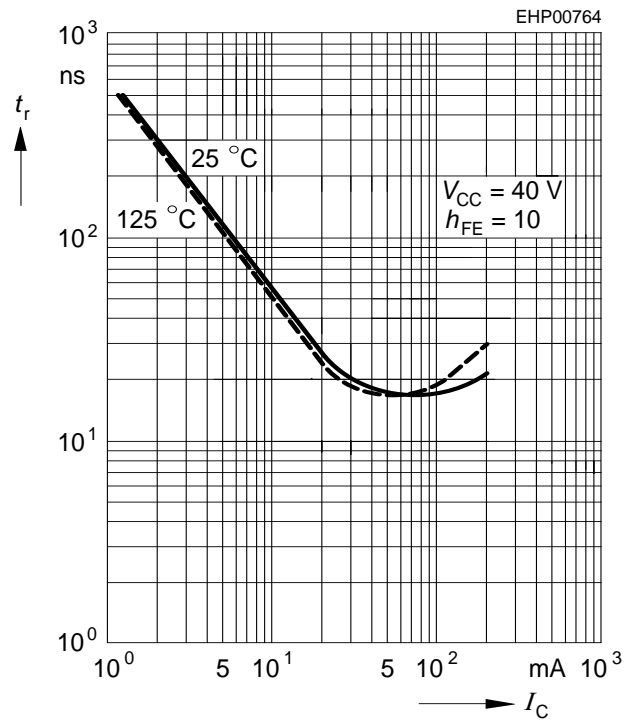

Input impedance

$$h_{11e} = f(I_C)$$

$V_{CE} = 10V, f = 1kHz$

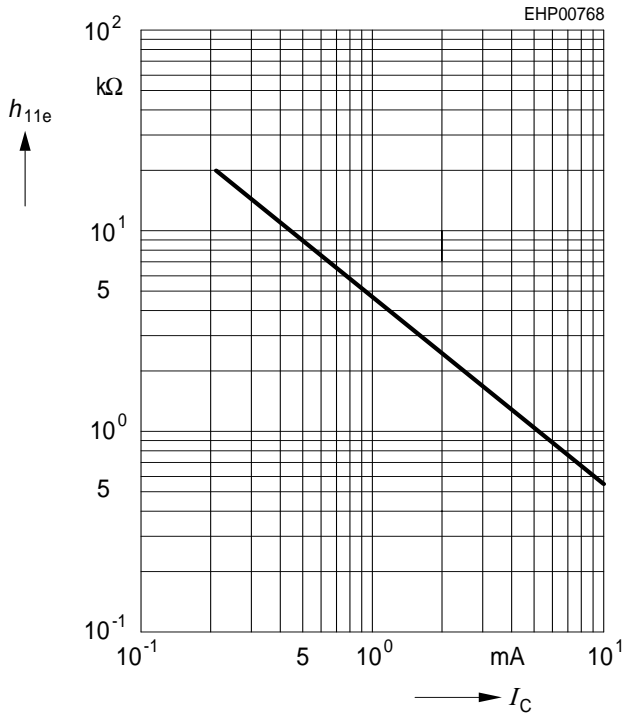

Open-circuit reverse voltage transfer ratio

$$h_{12e} = f(I_C)$$

$V_{CE} = 10V, f = 1kHz$

