



# Dual ECL and Dual/Quad PECL, 500ps, Ultra-High-Speed Comparators

## General Description

The MAX9600/MAX9601/MAX9602 ultra-high-speed comparators feature extremely low propagation delay (500ps). These dual and quad comparators minimize propagation delay skew (10ps) and are designed for low propagation delay dispersion (30ps). These features make them ideal for applications where high-fidelity tracking of narrow pulses and low timing dispersion is critical.

The differential input stage accepts a wide range of signals in the common-mode range from ( $V_{EE} + 3V$ ) to ( $V_{CC} - 2V$ ). The outputs are complementary digital signals, compatible with ECL and PECL systems, and provide sufficient current to directly drive transmission lines terminated in 50Ω.

The MAX9600/MAX9601 dual-channel ECL and dual-channel PECL output comparators incorporate latch enable ( $LE_{-}$ ,  $\overline{LE}_{-}$ ), and hysteresis ( $HYS_{-}$ ). The complementary latch-enable control permits tracking, track-hold, or sample-hold mode of operations. The latch enables can be driven with standard ECL logic for MAX9600 and PECL logic for MAX9601. The MAX9602 quad-channel PECL output comparator is ideal for high-density packaging in limited board space.

The MAX9600/MAX9601 are available in 20-pin TSSOP packages, and the MAX9602 is offered in a 24-pin TSSOP package. The MAX9600/MAX9601/MAX9602 are specified for operation from  $-40^{\circ}\text{C}$  to  $+85^{\circ}\text{C}$ .

## Applications

VLSI and High-Speed Memory ATE  
 High-Speed Instrumentation  
 Scope/Logic Analyzer Front Ends  
 High-Speed Triggering  
 Threshold and Peak Detection  
 Line Receiving/Signal Restoration

## Features

- ◆ 500ps Propagation Delay
- ◆ 30ps Propagation Delay Dispersion
- ◆ 4Gbps Tracking Frequency
- ◆ -2.2V to +3V Input Range with +5V/-5.2V Supplies
- ◆ -1.2V to +4V Input Range with +6V/-4.2V Supplies
- ◆ Differential ECL Outputs (MAX9600)
- ◆ Differential PECL Outputs (MAX9601/MAX9602)
- ◆ Latch Enable (MAX9600/MAX9601)
- ◆ Adjustable Hysteresis (MAX9600/MAX9601)

## Ordering Information

| PART       | TEMP RANGE                                     | PIN-PACKAGE |
|------------|--|-------------|
| MAX9600EUP | $-40^{\circ}\text{C}$ to $+85^{\circ}\text{C}$ | 20 TSSOP    |
| MAX9601EUP | $-40^{\circ}\text{C}$ to $+85^{\circ}\text{C}$ | 20 TSSOP    |
| MAX9602EUG | $-40^{\circ}\text{C}$ to $+85^{\circ}\text{C}$ | 24 TSSOP    |

## Selector Guide

| PART       | PIN-PACKAGE | SELECTION  |
|------------|-------------|--|
| MAX9600EUP | 20 TSSOP    | Dual ECL Output Comparator with Latch Enable and Hysteresis  |
| MAX9601EUP | 20 TSSOP    | Dual PECL Output Comparator with Latch Enable and Hysteresis |
| MAX9602EUG | 24 TSSOP    | Quad PECL Output Comparator                                  |

Pin Configurations appear at end of data sheet.

## Functional Diagrams

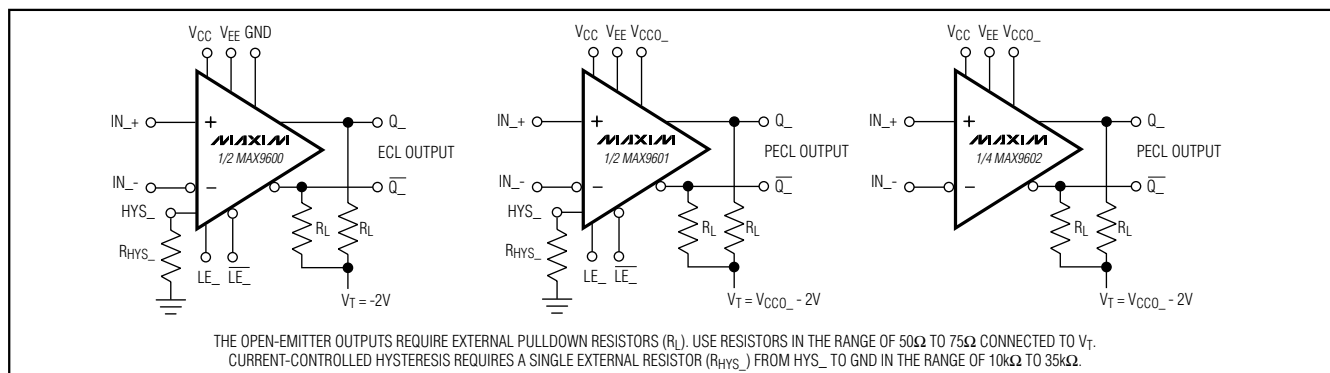

# Dual ECL and Dual/Quad PECL, 500ps, Ultra-High-Speed Comparators

## ABSOLUTE MAXIMUM RATINGS

|  |   |   |                                 |
|--|---|---|---------------------------------|
| $V_S = V_{CC} - V_{EE}$ .....                | 12.0V   | Input Current to Any Input Pin.....                                 | 10mA                            |
| $V_{CC}$ to GND (MAX9600) .....              | 6.8V  | HYS_ Current (MAX9600/MAX9601) .....                                | -1mA                            |
| $V_{EE}$ to GND (MAX9600) .....              | -6.5V   | Continuous Output Current.....                                      | 50mA                            |
| Differential Input Voltage .....             | $\pm 6.5V$                                    | Continuous Power Dissipation ( $T_A = +70^\circ C$ )                |                                 |
| Latch Differential Voltage .....             | $\pm 4V$                                      | 20-Pin TSSOP (derate 10.9mW/ $^\circ C$ above $+70^\circ C$ ) ..... | 879mW                           |
| Common-Mode Input Voltage ( $V_{CM}$ ) ..... | $V_{EE}$ to $V_{CC}$                          | 24-Pin TSSOP (derate 12.2mW/ $^\circ C$ above $+70^\circ C$ ) ..... | 975mW                           |
| $V_{CCO\_}$ to $V_{EE}$                      |   | Operating Temperature Range .....                                   | $-40^\circ C$ to $+85^\circ C$  |
| (MAX9601/MAX9602).....                       | ( $V_{EE} - 0.3V$ ) to ( $V_{CC} + 0.3V$ )    | Junction Temperature .....  | $+150^\circ C$                  |
| $LE\_ , \overline{LE\_}$ to GND              |   | Storage Temperature Range .....                                     | $-65^\circ C$ to $+150^\circ C$ |
| MAX9600 .....                                | ( $V_{EE} - 0.3V$ ) to $0.3V$                 | Lead Temperature (soldering, 10s) .....                             | $+300^\circ C$                  |
| MAX9601 .....                                | ( $V_{EE} - 0.3V$ ) to ( $V_{CCO\_} + 0.3V$ ) |   |                                 |

Stresses beyond those listed under "Absolute Maximum Ratings" may cause permanent damage to the device. These are stress ratings only, and functional operation of the device at these or any other conditions beyond those indicated in the operational sections of the specifications is not implied. Exposure to absolute maximum rating conditions for extended periods may affect device reliability.

## DC ELECTRICAL CHARACTERISTICS

( $V_{CC} = 5V$ ,  $V_{EE} = -5.2V$ ,  $V_{CM} = 0V$ , HYS\_ = open (MAX9600/MAX9601),  $LE\_ = low$ ,  $\overline{LE\_} = high$  (MAX9600/MAX9601), GND = 0V,  $R_L = 50\Omega$  to  $-2V$  (MAX9600),  $V_{CCO\_} = 5V$ ,  $R_L = 50\Omega$  to  $3V$  (MAX9601/MAX9602),  $T_A = T_{MIN}$  to  $T_{MAX}$ . Typical values are at  $T_A = +25^\circ C$ , unless otherwise noted.) (Note 1)

| PARAMETER  | SYMBOL                          | CONDITIONS   | MIN                     | TYP               | MAX          | UNITS            |
|--|---------------------------------|--|-------------------------|-------------------|--------------|------------------|
| <b>INPUT (IN_+, IN_-)</b>                                |                                 |  |                         |                   |              |                  |
| Input Differential Voltage Range                         | $V_{ID}$                        | Guaranteed by input bias current tests                         | -5.2                    |                   | +5.2         | V                |
| Input Common-Mode Voltage                                | $V_{CM}$                        | Guaranteed by input bias current tests                         | $V_{EE} + 3$            |                   | $V_{CC} - 2$ | V                |
| Input Offset Voltage                                     | $V_{OS}$                        | $T_A = +25^\circ C$  |                         | $\pm 1$           | $\pm 5$      | mV               |
|  |                                 | $T_{MIN} \leq T_A \leq T_{MAX}$                                |                         |                   | $\pm 9$      |                  |
| Input Offset-Voltage Tempco                              | $TCV_{OS}$                      |  |                         | 8                 |              | $\mu V/^\circ C$ |
| Input Offset-Voltage Channel Matching                    |                                 |  |                         | 1                 |              | mV               |
| Input Bias Current                                       | $I_B$                           | $V_{ID} = \pm 5.2V$  |                         | 6                 | 20           | $\mu A$          |
| Input Bias-Current Tempco                                | $TCI_B$                         |  |                         | 10                |              | $nA/^\circ C$    |
| Input Offset Current                                     | $I_{OS}$                        |  |                         | 0.3               | $\pm 5$      | $\mu A$          |
| Input Resistance   | $R_{IN}$                        | Differential mode ( $V_{ID} \leq 10mV$ )                       |                         | 10                |              | $k\Omega$        |
|  |                                 | Common mode ( $(V_{EE} + 3V) \leq V_{CM} \leq (V_{CC} - 2V)$ ) |                         | 100               |              | $M\Omega$        |
| <b>LATCH INPUT (<math>LE\_ , \overline{LE\_}</math>)</b> |                                 |  |                         |                   |              |                  |
| Latch Differential Input Voltage                         | $V_{LD}$                        | Guaranteed by latch input current                              | MAX9600                 | 0.4               | 2.0          | V                |
|  |                                 |  | MAX9601                 | 0.25              | 3.50         |                  |
| Latch Input Voltage Range                                | $V_{LR}$                        | MAX9600  | -2                      | 0                 | V            |                  |
|  |                                 | MAX9601  | $V_{CCO\_} \geq 3.5V$   | $V_{CCO\_} - 3.5$ |              | $V_{CCO\_}$      |
|  |                                 |  | $V_{CCO\_} < 3.5V$      | 0                 |              | $V_{CCO\_}$      |
| Latch Input Current                                      | $I_{LE\_}, I_{\overline{LE\_}}$ | MAX9600  |                         | 5                 | 20           | $\mu A$          |
|  |                                 | MAX9601  |                         | 5                 | 20           |                  |
| <b>HYSTERESIS INPUT (HYS_)</b>                           |                                 |  |                         |                   |              |                  |
| Input-Referred Hysteresis                                |                                 | MAX9600/MAX9601  | $R_{HYS} = \infty$      | 0                 |              | mV               |
|  |                                 |  | $R_{HYS} = 16.4k\Omega$ | 30                |              |                  |

# Dual ECL and Dual/Quad PECL, 500ps, Ultra-High-Speed Comparators

**MAX9600/MAX9601/MAX9602**

## DC ELECTRICAL CHARACTERISTICS (continued)

( $V_{CC} = 5V$ ,  $V_{EE} = -5.2V$ ,  $V_{CM} = 0V$ ,  $HYS_{-} = \text{open}$  (MAX9600/MAX9601),  $LE_{-} = \text{low}$ ,  $\overline{LE}_{-} = \text{high}$  (MAX9600/MAX9601),  $GND = 0V$ ,  $R_L = 50\Omega$  to  $-2V$  (MAX9600),  $V_{CCO_{-}} = 5V$ ,  $R_L = 50\Omega$  to  $3V$  (MAX9601/MAX9602),  $T_A = T_{MIN}$  to  $T_{MAX}$ . Typical values are at  $T_A = +25^{\circ}C$ , unless otherwise noted.) (Note 1)

| PARAMETER  | SYMBOL        | CONDITIONS  |                 | MIN                     | TYP                     | MAX                     | UNITS |
|--|---------------|---|-----------------|-------------------------|-------------------------|-------------------------|-------|
| <b>OUTPUT (Q<sub>-</sub>, <math>\overline{Q}_{-}</math>)</b> |               |   |                 |                         |                         |                         |       |
| Logic Output High Voltage                                    | $V_{OH}$      | $T_A = +25^{\circ}C$  | MAX9600         | -1.10                   | -0.94                   | -0.75                   | V     |
|  |               |   | MAX9601/MAX9602 | $V_{CCO_{-}}$<br>- 1.10 | $V_{CCO_{-}}$<br>- 0.94 | $V_{CCO_{-}}$<br>- 0.75 |       |
|  |               | $T_A = T_{MIN}$   | MAX9600         | -1.2                    | -1.02                   | -0.8                    |       |
|  |               |   | MAX9601/MAX9602 | $V_{CCO_{-}}$<br>- 1.2  | $V_{CCO_{-}}$<br>- 1.02 | $V_{CCO_{-}}$<br>- 0.8  |       |
|  |               | $T_A = T_{MAX}$   | MAX9600         | -1.05                   | -0.87                   | -0.70                   |       |
|  |               |   | MAX9601/MAX9602 | $V_{CCO_{-}}$<br>- 1.05 | $V_{CCO_{-}}$<br>- 0.87 | $V_{CCO_{-}}$<br>- 0.70 |       |
| Logic Output Low Voltage                                     | $V_{OL}$      | $T_A = +25^{\circ}C$  | MAX9600         | -1.95                   | -1.72                   | -1.55                   | V     |
|  |               |   | MAX9601/MAX9602 | $V_{CCO_{-}}$<br>- 1.95 | $V_{CCO_{-}}$<br>- 1.72 | $V_{CCO_{-}}$<br>- 1.55 |       |
|  |               | $T_A = T_{MIN}$   | MAX9600         | -2.0                    | -1.78                   | -1.6                    |       |
|  |               |   | MAX9601/MAX9602 | $V_{CCO_{-}}$<br>- 2.0  | $V_{CCO_{-}}$<br>- 1.78 | $V_{CCO_{-}}$<br>- 1.6  |       |
|  |               | $T_A = T_{MAX}$   | MAX9600         | -1.9                    | -1.66                   | -1.50                   |       |
|  |               |   | MAX9601/MAX9602 | $V_{CCO_{-}}$<br>- 1.9  | $V_{CCO_{-}}$<br>- 1.66 | $V_{CCO_{-}}$<br>- 1.5  |       |
| <b>SUPPLY</b>  |               |   |                 |                         |                         |                         |       |
| Positive Supply Voltage                                      | $V_{CC}$      | Guaranteed by output swing tests  |                 | 4.3                     | 5                       | 6.3                     | V     |
| Negative Supply Voltage                                      | $V_{EE}$      | Guaranteed by output swing tests  |                 | -6                      | -5.2                    | -4                      | V     |
| Supply Voltage Difference                                    | $V_S$         | $V_S = (V_{CC} - V_{EE})$ , guaranteed by output swing tests                              |                 | 9.5                     |                         | 11.5                    | V     |
| Logic Supply Voltage   | $V_{CCO_{-}}$ | MAX9601/MAX9602   |                 | 2.4                     |                         | $V_{CC}$                | V     |
| Positive Supply Current                                      | $I_{CC}$      | (Note 2)  | MAX9600         |                         | 16                      | 24                      | mA    |
|  |               |   | MAX9601         |                         | 19                      | 27                      |       |
|  |               |   | MAX9602         |                         | 28                      | 39                      |       |
| Negative Supply Current                                      | $I_{EE}$      | (Note 2)  | MAX9600         |                         | 21                      | 28                      | mA    |
|  |               |   | MAX9601         |                         | 24                      | 33                      |       |
|  |               |   | MAX9602         |                         | 38                      | 49                      |       |
| Power-Supply Dissipation                                     | $P_{DISS}$    | (Note 2)  | MAX9600         |                         | 190                     | 266                     | mW    |
|  |               |   | MAX9601         |                         | 220                     | 307                     |       |
|  |               |   | MAX9602         |                         | 338                     | 450                     |       |
| Common-Mode Rejection Ratio                                  | CMRR          | $(V_{EE} + 3V) \leq V_{CM} \leq (V_{CC} - 2V)$  |                 |                         | 70                      |                         | dB    |
| Power-Supply Rejection Ratio                                 | PSRR          | $4.3V \leq V_{CC} \leq 6.3V$ , $-6V \leq V_{EE} \leq -4V$ ,<br>$9.5V \leq V_S \leq 11.5V$ |                 |                         | 65                      |                         | dB    |

# Dual ECL and Dual/Quad PECL, 500ps, Ultra-High-Speed Comparators

## AC ELECTRICAL CHARACTERISTICS

( $V_{CC} = 5V$ ,  $V_{EE} = -5.2V$ ,  $V_{CM} = 0V$ ,  $HYS_- = \text{open}$  (MAX9600/MAX9601),  $LE_- = \text{low}$ ,  $\overline{LE}_- = \text{high}$  (MAX9600/MAX9601),  $C_L = 5pF$ ,  $GND = 0V$ ,  $R_L = 50\Omega$  to  $-2V$  (MAX9600),  $V_{CCO_-} = 5V$ ,  $R_L = 50\Omega$  to  $3V$  (MAX9601/MAX9602),  $T_A = T_{MIN}$  to  $T_{MAX}$ . Typical values are at  $T_A = +25^\circ C$ , unless otherwise noted.) (Note 1)

| PARAMETER  | SYMBOL                                      | CONDITIONS  | MIN | TYP | MAX | UNITS          |
|--|---|---|-----|-----|-----|----------------|
| Tracking Frequency Toggle Rate                   | $f_{MAX}$                                   | $V_{OUT} = 550mV_{P-P}$ , input overdrive = 100mV |     | 4   |     | Gbps           |
| Minimum Pulse Width                              | $t_{PW}$                                    | $V_{OUT} = 550mV_{P-P}$ , input overdrive = 100mV |     | 250 |     | ps             |
| Propagation Delay                                | $t_{PD-}$ , $t_{PD+}$                       | Input overdrive = 100mV, Figure 1, (Note 3)       |     | 500 | 700 | ps             |
| Propagation Delay Tempco                         | $TCt_{PD}$                                  |   |     | 0.5 |     | ps/ $^\circ C$ |
| Propagation Delay Skew                           | $t_{PDSKEW}$                                | Input overdrive = 100mV (Note 4)                  |     | 10  |     | ps             |
| Propagation Delay Match                          |   | Input overdrive = 100mV (Note 5)                  |     | 40  |     | ps             |
| Propagation Delay Dispersion Overdrive           |   | 10mV to 100mV                                     |     | 15  |     | ps             |
|  |   | 100mV to 2V                                       |     | 40  |     |                |
| Propagation Delay Dispersion Common-Mode Voltage |   | $(V_{EE} + 3V) \leq V_{CM} \leq (V_{CC} - 2V)$    |     | 10  |     | ps             |
| Propagation Delay Dispersion Input Slew Rate     | $V_{IN} = 1V_{P-P}$ input overdrive = 100mV | 0.2V/ns to 10V/ns                                 |     | 40  |     |                |
| Propagation Delay Dispersion Duty Cycle          |   | 10% to 90% at 250MHz                              |     | 30  |     |                |
| Propagation Delay Dispersion Pulse Width         |   | 350ps to 1ns                                      |     | 20  |     |                |
| Unit-to-Unit Propagation Delay Match             |   | Input overdrive = 100mV                           |     | 50  |     | ps             |
| Output Jitter                                    |   | $V_{IN} = 2V_{P-P}$ ; 50MHz                       |     | 300 |     | fs             |
| Input Capacitance                                | $C_{IN}$                                    | $IN_+$ or $IN_-$ , with respect to GND            |     | 2   |     | pF             |
| Latch Setup Time                                 | $t_{LS}$                                    | Figure 1, (Notes 3, 6)                            | 250 | 80  |     | ps             |
| Latch Hold Time                                  | $t_{LH}$                                    | Figure 1, (Notes 3, 6)                            | 300 | 85  |     | ps             |
| Minimum Pulse Width                              | $t_{LPW}$                                   | Figure 1  |     | 250 |     | ps             |
| Latch to Output Delay                            | $t_{LPD}$                                   | Figure 1  |     | 200 |     | ps             |
| Rise Time and Fall Time                          | $t_R$ , $t_F$                               | 20% to 80%, Figure 1                              |     | 200 |     | ps             |

**Note 1:** All devices are 100% production tested at  $T_A = +25^\circ C$ . Specifications over temperature are guaranteed by design.

**Note 2:** Does not include output state current in  $Q_-$ ,  $\overline{Q}_-$ .

**Note 3:** Guaranteed by design.

**Note 4:** Propagation delay skew ( $t_{PDSKEW}$ ) is for a single channel and is the difference between the propagation delay to the high-to-low output transition vs. the low-to-high output transition.

**Note 5:** Propagation delay match is the difference of  $t_{PD-}$  or  $t_{PD+}$  of one channel to the  $t_{PD-}$  or  $t_{PD+}$  of another channel of the same device.

**Note 6:** Latch setup and hold-timing specifications are for a differentially driven latch signal.

# Dual ECL and Dual/Quad PECL, 500ps, Ultra-High-Speed Comparators

## Typical Operating Characteristics

( $V_{CC} = 5V$ ,  $V_{EE} = -5.2V$ ,  $V_{CM} = 0V$ ,  $HYS_{-}$  = open (MAX9600/MAX9601),  $LE_{-}$  = low,  $\overline{LE}_{-}$  = high (MAX9600/MAX9601),  $C_L = 5pF$ ,  $GND = 0V$ ,  $R_L = 50\Omega$  to  $-2V$  (MAX9600),  $V_{CCO_{-}} = 5V$ ,  $R_L = 50\Omega$  to  $3V$  (MAX9601/MAX9602), input slew rate =  $2V/ns$ , duty cycle = 50%,  $T_A = T_{MIN}$  to  $T_{MAX}$ . Typical values are at  $T_A = +25^{\circ}C$ , unless otherwise noted.) (Note 1)

MAX9600/MAX9601/MAX9602

**PROPAGATION DELAY vs. INPUT OVERDRIVE**  
( $V_{CC} = 10mV$  TO  $100mV$ )

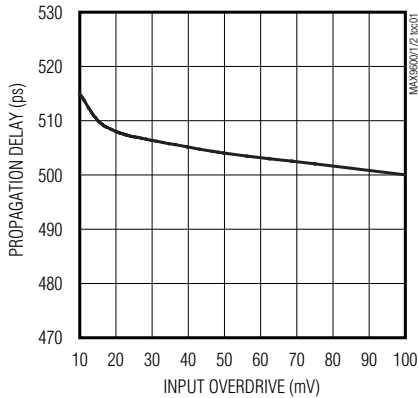

**PROPAGATION DELAY vs. INPUT OVERDRIVE**  
( $V_{OD} = 0.1V$  TO  $2V$ )

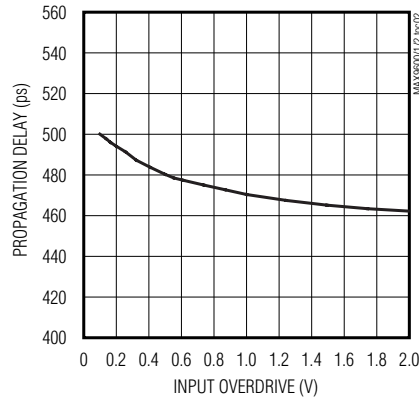

**PROPAGATION DELAY vs. SOURCE IMPEDANCE**

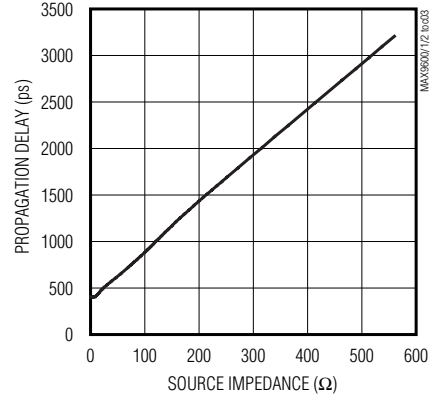

**PROPAGATION DELAY vs. CAPACITIVE LOAD**

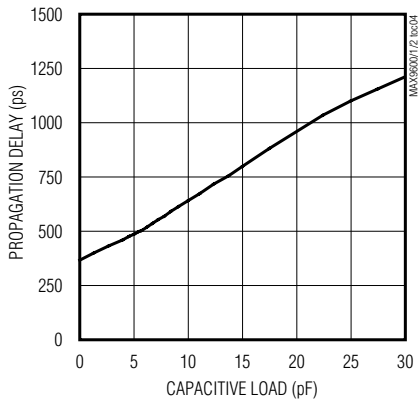

**PROPAGATION DELAY vs. TEMPERATURE**

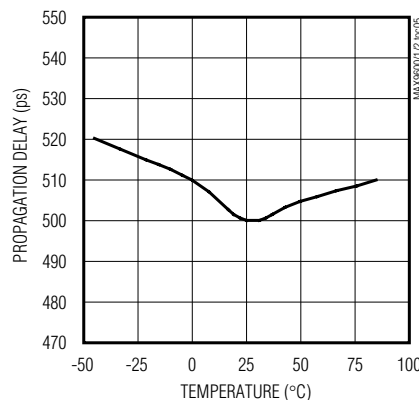

**PROPAGATION DELAY vs. COMMON-MODE VOLTAGE**

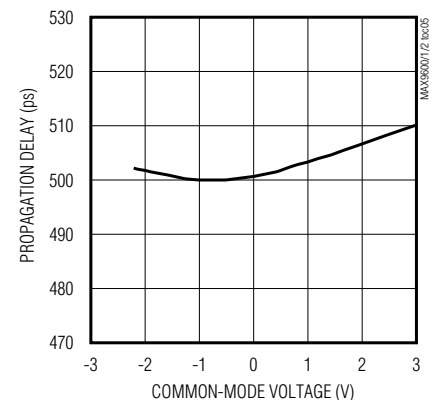

# Dual ECL and Dual/Quad PECL, 500ps, Ultra-High-Speed Comparators

## Typical Operating Characteristics (continued)

( $V_{CC} = 5V$ ,  $V_{EE} = -5.2V$ ,  $V_{CM} = 0V$ ,  $HYS_{-} = \text{open}$  (MAX9600/MAX9601),  $LE_{-} = \text{low}$ ,  $\overline{LE}_{-} = \text{high}$  (MAX9600/MAX9601),  $C_L = 5pF$ ,  $GND = 0V$ ,  $R_L = 50\Omega$  to  $-2V$  (MAX9600),  $V_{CCO_{-}} = 5V$ ,  $R_L = 50\Omega$  to  $3V$  (MAX9601/MAX9602), input slew rate =  $2V/ns$ , duty cycle = 50%,  $T_A = T_{MIN}$  to  $T_{MAX}$ . Typical values are at  $T_A = +25^{\circ}C$ , unless otherwise noted.) (Note 1)

**PROPAGATION DELAY vs. PULSE WIDTH**

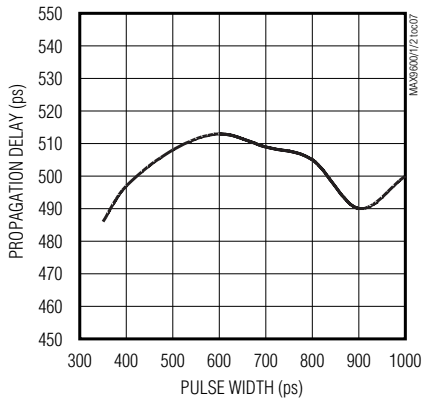

**PROPAGATION DELAY vs. INPUT SLEW RATE**

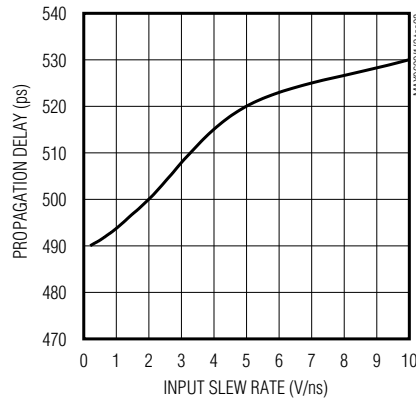

**PROPAGATION DELAY vs. DUTY CYCLE**

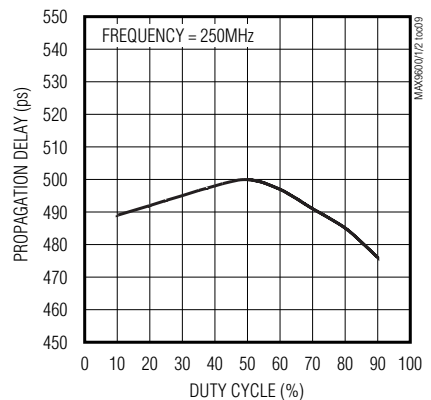

**INPUT OFFSET VOLTAGE vs. TEMPERATURE**

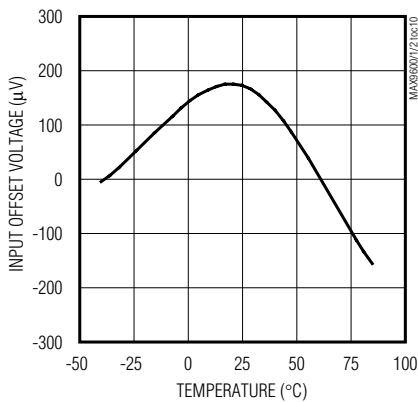

**HYSTERESIS vs. R<sub>HYS</sub> TO GND**

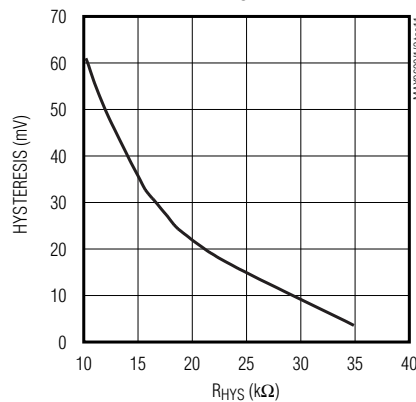

**HYSTERESIS vs. TEMPERATURE**

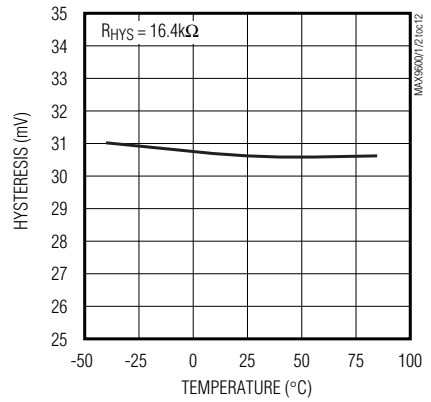

# Dual ECL and Dual/Quad PECL, 500ps, Ultra-High-Speed Comparators

## Typical Operating Characteristics (continued)

( $V_{CC} = 5V$ ,  $V_{EE} = -5.2V$ ,  $V_{CM} = 0V$ ,  $HYS_{-} = \text{open}$  (MAX9600/MAX9601),  $LE_{-} = \text{low}$ ,  $\overline{LE}_{-} = \text{high}$  (MAX9600/MAX9601),  $C_L = 5pF$ ,  $GND = 0V$ ,  $R_L = 50\Omega$  to  $-2V$  (MAX9600),  $V_{CCO_{-}} = 5V$ ,  $R_L = 50\Omega$  to  $3V$  (MAX9601/MAX9602), input slew rate =  $2V/ns$ , duty cycle = 50%,  $T_A = T_{MIN}$  to  $T_{MAX}$ . Typical values are at  $T_A = +25^{\circ}C$ , unless otherwise noted.) (Note 1)

MAX9600/MAX9601/MAX9602

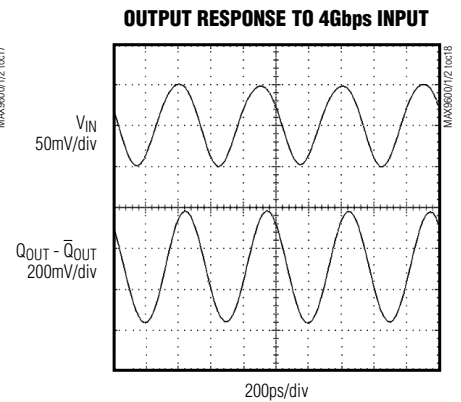
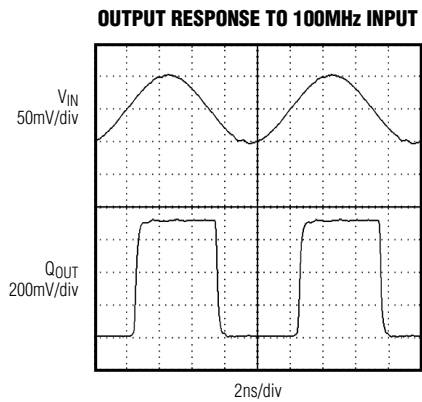
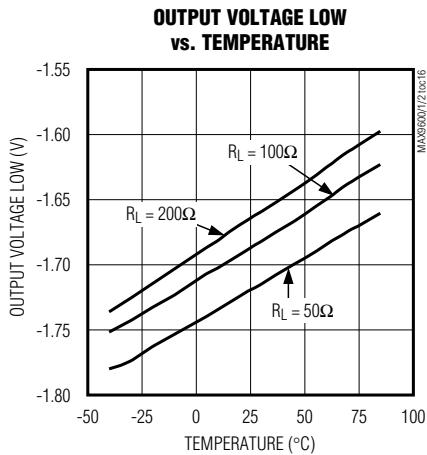
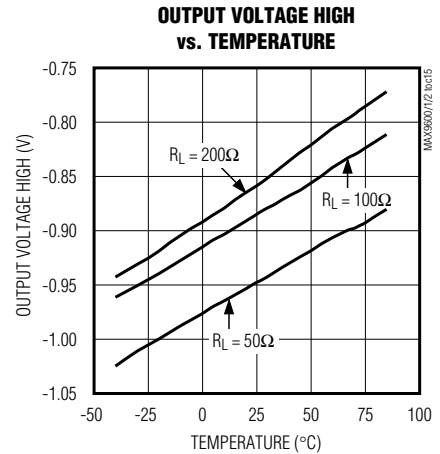
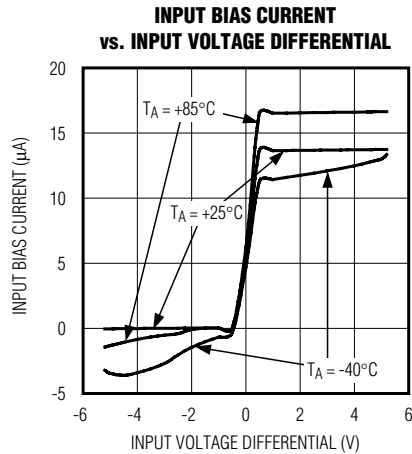
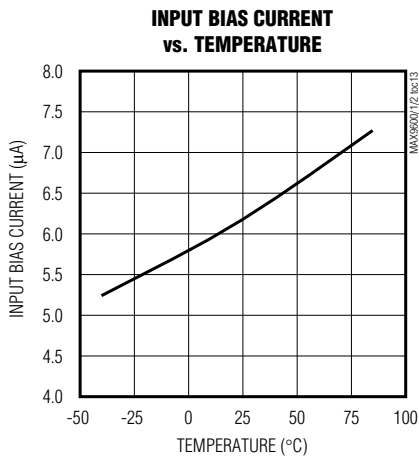

# Dual ECL and Dual/Quad PECL, 500ps, Ultra-High-Speed Comparators

## Timing Diagram

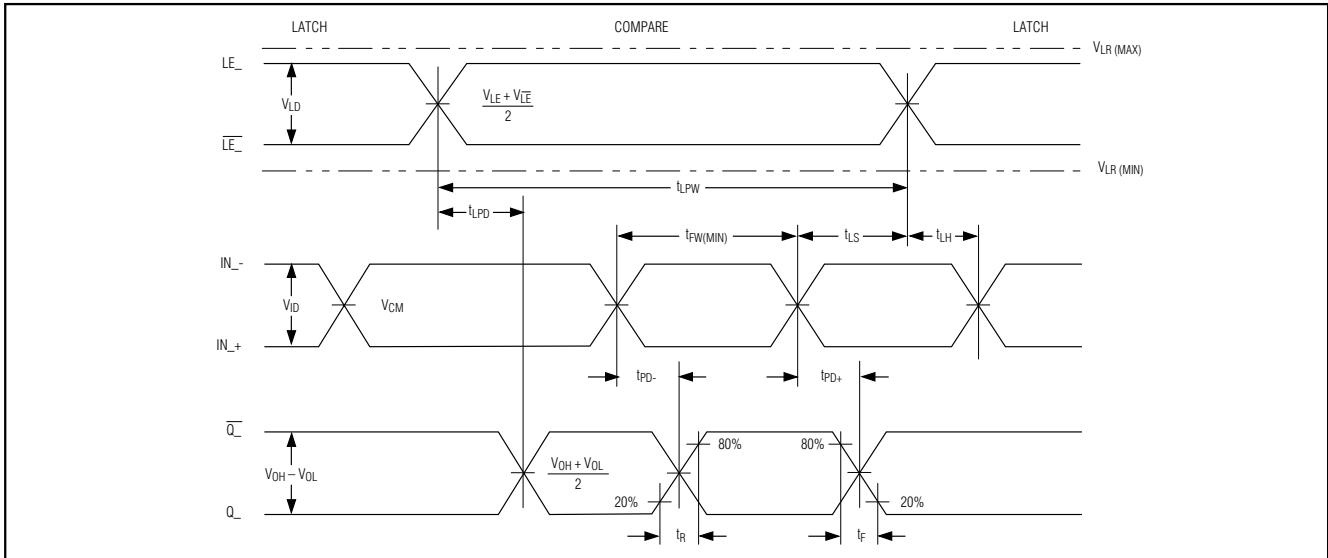

Figure 1. MAX9600/MAX9601/MAX9602 Timing Diagram

## Pin Descriptions

### MAX9600/MAX9601

| PIN     |         | NAME             | FUNCTION                                   |
|---------|---------|------------------|--|
| MAX9600 | MAX9601 |                  |  |
| 1       | 1       | QA               | Channel A Output                           |
| 2       | 2       | $\overline{QA}$  | Channel A Complementary Output             |
| 3       | —       | GND              | Channel A Output Ground                    |
| —       | 3       | VCCOA            | Channel A Output Driver Positive Supply    |
| 4       | 4       | LEA              | Channel A Latch-Enable Input               |
| 5       | 5       | $\overline{LEA}$ | Channel A Latch-Enable Complementary Input |
| 6, 15   | 6, 15   | VEE              | Negative Supply Voltage                    |
| 7, 14   | 7, 14   | VCC              | Positive Supply Voltage                    |
| 8       | 8       | HYSA             | Channel A Hysteresis Input                 |
| 9       | 9       | INA-             | Channel A Minus Input                      |
| 10      | 10      | INA+             | Channel A Plus Input                       |
| 11      | 11      | INB+             | Channel B Plus Input                       |
| 12      | 12      | INB-             | Channel B Minus Input                      |
| 13      | 13      | HYSB             | Channel B Hysteresis Input                 |
| 16      | 16      | $\overline{LEB}$ | Channel B Latch-Enable Complementary Input |
| 17      | 17      | LEB              | Channel B Latch-Enable Input               |
| 18      | —       | GND              | Channel B Output Ground                    |
| —       | 18      | VCCOB            | Channel B Output Driver Positive Supply    |
| 19      | 19      | $\overline{QB}$  | Channel B Complementary Output             |
| 20      | 20      | QB               | Channel B Output                           |



# Dual ECL and Dual/Quad PECL, 500ps, Ultra-High-Speed Comparators

## Pin Descriptions (continued)

### MAX9602

| PIN   | NAME              | FUNCTION                                |
|-------|-------------------|---|
| 1     | INA+              | Channel A Plus Input                    |
| 2     | INA-              | Channel A Minus Input                   |
| 3, 9  | V <sub>EE</sub>   | Negative Supply Voltage                 |
| 4     | INB+              | Channel B Plus Input                    |
| 5     | INB-              | Channel B Minus Input                   |
| 6, 12 | V <sub>CC</sub>   | Positive Supply Voltage                 |
| 7     | INC+              | Channel C Plus Input                    |
| 8     | INC-              | Channel C Minus Input                   |
| 10    | IND+              | Channel D Plus Input                    |
| 11    | IND-              | Channel D Minus Input                   |
| 13    | $\overline{QD}$   | Channel D Complementary Output          |
| 14    | QD                | Channel D Output                        |
| 15    | V <sub>CCOD</sub> | Channel D Output Driver Positive Supply |
| 16    | $\overline{QC}$   | Channel C Complementary Output          |
| 17    | QC                | Channel C Output                        |
| 18    | V <sub>CCOC</sub> | Channel C Output Driver Positive Supply |
| 19    | $\overline{QB}$   | Channel B Complementary Output          |
| 20    | QB                | Channel B Output                        |
| 21    | V <sub>CCOB</sub> | Channel B Output Driver Positive Supply |
| 22    | QA                | Channel A Complementary Output          |
| 23    | QA                | Channel A Output                        |
| 24    | V <sub>CCOA</sub> | Channel A Output Driver Positive Supply |

### Detailed Description

The MAX9600/MAX9601/MAX9602 ultra-high-speed comparators feature extremely low propagation delay (500ps). These dual and quad comparators minimize channel-to-channel skew (10ps) and are designed for low propagation delay dispersion. These features make them ideal for applications where high-fidelity tracking of narrow pulses and low timing dispersion is critical. The devices operate from either standard supply levels of -5.2V/+5V or shifted levels of -4.2V/+6V.

The differential input stage accepts a wide range of signals in the common-mode range from (V<sub>EE</sub> + 3V) to (V<sub>CC</sub> - 2V) with a CMRR of 70dB (typ). The outputs are complementary digital signals, compatible with ECL and PECL systems, and provide sufficient current to directly drive transmission lines terminated in 50Ω. The ultra-fast operation makes signal processing possible at a data rate up to 4Gbps. Figure 2 shows a 1Gbps (500MHz) example with an input-signal level of 100mV<sub>p-p</sub>.

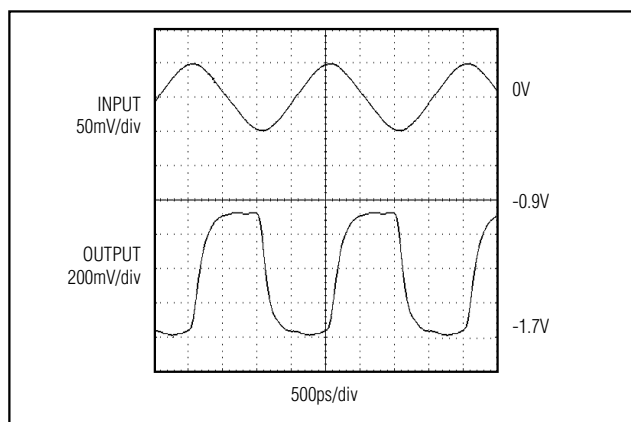

Figure 2. Signal Processed at 500MHz with Input-Signal Level of 100mV<sub>RMS</sub>.

## Dual ECL and Dual/Quad PECL, 500ps, Ultra-High-Speed Comparators

The MAX9600/MAX9601 incorporate latch-enable and hysteresis control. Hysteresis rejects noise and prevents oscillations on low-slew input signals. The latch-enable control permits tracking or sampling mode of operations. Drive the complementary latch enable with standard ECL logic for MAX9600 and PECL logic for MAX9601. The MAX9602 quad-channel PECL output comparator does not include the latch-enable or hysteresis control functions.

### Applications Information

#### Layout

Special layout precautions exist due to the large gain-bandwidth characteristic of the MAX9600/MAX9601/MAX9602. Use a printed circuit board with a good, low-inductance ground plane. Mount 0.01 $\mu$ F ceramic decoupling capacitors as close to the power-supply inputs as possible. Minimize lead lengths on the inputs and outputs to avoid unwanted parasitic feedback around the comparators. Use surface-mount chip components to minimize lead inductance. Pay close attention to the bandwidth of the decoupling and terminating components.

Use microstrip layout and terminations at the input and output. Avoid discontinuities in differential impedance. Maximize common-mode noise immunity by maintaining the distance between differential traces and avoid sharp corners. Minimize the number of vias to prevent impedance discontinuities. Match the electrical length of the traces to minimize skew.

#### Input Slew-Rate Requirements

As with all high-speed comparators, the high gain-bandwidth product of these devices can create oscillation problems when the input goes through the threshold region. This is typically due to parasitic paths, which cause positive feedback to occur. For clean switching without oscillation or steps in the output waveform for the MAX9600/MAX9601, use an input with a slew rate of 5V/ $\mu$ s or faster. For the MAX9602, use a slew rate of 25V/ $\mu$ s or faster. The tendency of the part to oscillate is a function of the layout and source impedance of the circuit employed. Poor layout and larger source impedance increases the minimum slew-rate requirement. Adding hysteresis accommodates slower inputs (see the *Hysteresis* section).

#### Hysteresis (MAX9600/MAX9601)

Hysteresis can be introduced to prevent oscillation or multiple transitions due to noise. The MAX9600/MAX9601 feature current-controlled hysteresis, which is set by placing a resistor between HYS\_ and GND. The value of the current-setting resistor is determined by the

output voltage of 2.5V at HYS\_ divided by the desired hysteresis current level in the range of 0 to 200 $\mu$ A. R<sub>HYS</sub> of 10k $\Omega$  to 35k $\Omega$  resistors provides hysteresis of 60mV to 5mV (see the Hysteresis vs. R<sub>HYS</sub> to GND graph in the *Typical Operating Characteristics* section). For a zero hysteresis (0 $\mu$ A hysteresis current), leave HYS\_ open or connect it to V<sub>CC</sub>.

#### Propagation Delay Dispersion

Propagation delay dispersion is defined as a variation in propagation delay as a function of change in input conditions. In an automatic test system pin-driver electronics, for example, the dispersion determines the maximum edge resolution.

Many factors can affect the dispersion, such as common-mode voltage, overdrive, input slew rate, duty cycle, and pulse width. The typical propagation delay dispersions of the MAX9600/MAX9601/MAX9602 are less than 10ps to 40ps (see the *Typical Operating Characteristics* and *Electrical Characteristics* sections).

#### Comparators with Latch Enable (MAX9600/MAX9601)

The latch-enable function allows the comparator to be used in a sampling mode. When LE\_ is low ( $\overline{LE}_$  is high), the comparator tracks the input signal. When LE\_ is driven high ( $\overline{LE}_$  is low), the outputs are forced to an unambiguous logic state, dependent on the input conditions at the time of the latch input transition. If the latch-enable function is not used, connect the appropriate LE\_ input to a low ECL/PECL logic, and its complementary  $\overline{LE}_$  input to a high ECL/PECL logic level (see Table 1).

The input range of the MAX9600 differential latch-enable inputs is 400mV to 2V. The logic-input swing excursion must fall within an input-voltage range (V<sub>LR</sub>) of -2V to 0 to work properly. The input range of the MAX9601 differential latch-enable inputs is 250mV to 3.5V. The logic-input swing excursion must fall within an input-voltage range (V<sub>LR</sub>) of 0 to 3.5V for (V<sub>CCO\_</sub> < 3.5V) or V<sub>LR</sub> of (V<sub>CCO\_</sub> - 3.5V) to V<sub>CCO\_</sub> for (V<sub>CCO\_</sub>  $\geq$  3.5V) to work properly.

Table 1. Latch-Enable Truth Table

| LATCH-ENABLE INPUT |                  | OPERATION  |
|--------------------|------------------|--|
| LE_                | $\overline{LE}_$ |  |
| 0                  | 1                | Compare Mode. Output follows input state.              |
| 1                  | 0                | Latch Mode. Output latches to last known output state. |
| 0                  | 0                | Invalid condition, output is in unknown state.         |
| 1                  | 1                | Invalid condition, output is in unknown state.         |

# Dual ECL and Dual/Quad PECL, 500ps, Ultra-High-Speed Comparators

## Timing Information (MAX9600/MAX9601)

The timing diagram (Figure 1) illustrates the operation of a comparator with latch enable. The top line of the diagram illustrates a latch-enable pulse. Initially, the latch-enable input (LE,  $\overline{LE}$ ) is differentially high, which places the comparator in latch mode. When the input signal (IN<sub>+</sub>, IN<sub>-</sub>) switches from low to high, the output (Q<sub>-</sub>,  $\overline{Q}$ ) remains latched to the previous low state. When the latch-enable input goes differentially low, starting the compare function, the output responds to the input and transitions to high after a time ( $t_{LPD}$ ). The leading edges of the subsequent input signal switch the comparator after time interval  $t_{PD+}$  or  $t_{PD-}$  (depending on the direction of the input transitions) until a high latch-enable pulse places the device in latch mode again. The input signal must occur at minimum time ( $t_{LS}$ ) before the latch rising edge, and must maintain its state for at least  $t_{LH}$  after the rising edge. A minimum latch-pulse width ( $t_{LPW}$ ) of 250ps (typ) is needed for proper latch operation.

## ECL/PCL

The MAX9600/MAX9601/MAX9602 outputs are emitter followers that require external resistive connections to a voltage source ( $V_T$ ) more negative than the lowest  $V_{OL}$  for proper static and dynamic operation. When properly terminated, the outputs provide appropriate levels,  $V_{OL}$  or  $V_{OH}$ , for ECL (MAX9600) or PECL (MAX9601/MAX9602). Output-current polarity always sinks into the termination scheme during proper operation.

ECL-output signal levels are referenced to GND, and PECL-output signals are referenced to  $V_{CCO-}$ .

## Chip Information

MAX9600 TRANSISTOR COUNT: 558  
 MAX9601 TRANSISTOR COUNT: 600  
 MAX9602 TRANSISTOR COUNT: 608  
 PROCESS: Bipolar

MAX9600/MAX9601/MAX9602

## Pin Configurations

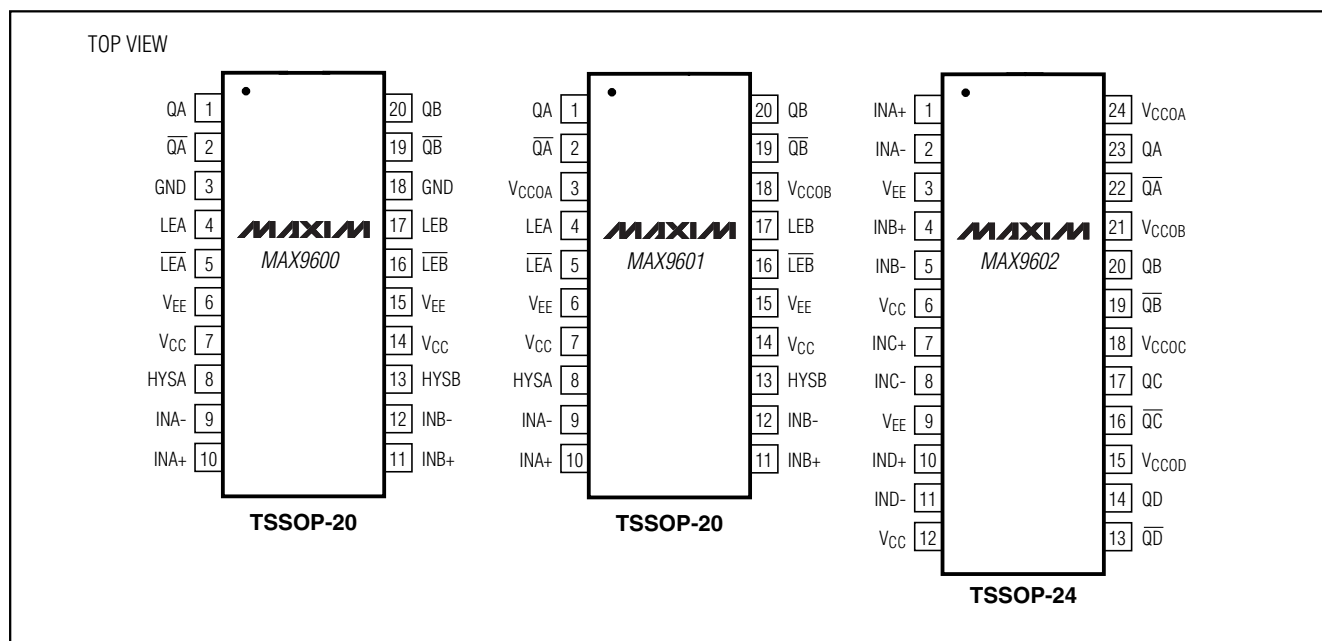

# Dual ECL and Dual/Quad PECL, 500ps, Ultra-High-Speed Comparators

## Package Information

(The package drawing(s) in this data sheet may not reflect the most current specifications. For the latest package outline information, go to [www.maxim-ic.com/packages](http://www.maxim-ic.com/packages).)

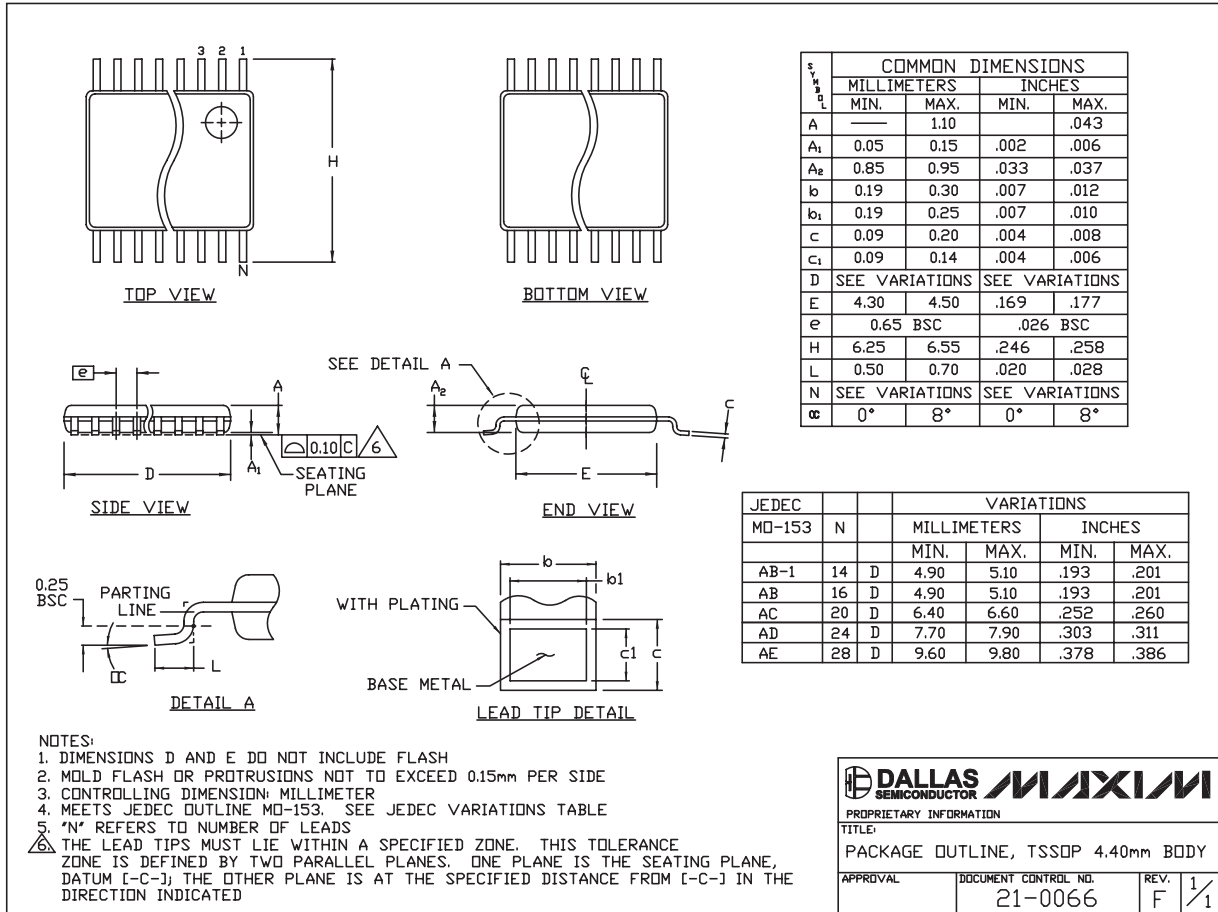

TSSOP4.40mm EP5

Maxim cannot assume responsibility for use of any circuitry other than circuitry entirely embodied in a Maxim product. No circuit patent licenses are implied. Maxim reserves the right to change the circuitry and specifications without notice at any time.

12 **Maxim Integrated Products, 120 San Gabriel Drive, Sunnyvale, CA 94086 408-737-7600**