

**Rectifier diodes  
ultrafast**

**BYW29F series**

**GENERAL DESCRIPTION**

Glass passivated high efficiency rectifier diodes in full pack, plastic envelopes, featuring low forward voltage drop, ultra-fast recovery times and soft recovery characteristic. They are intended for use in switched mode power supplies and high frequency circuits in general where low conduction and switching losses are essential.

**QUICK REFERENCE DATA**

SYMBOL	PARAMETER	MAX.	MAX.	MAX.	UNIT
$V_{RRM}$	<b>BYW29F-</b> Repetitive peak reverse voltage	<b>100</b> 100	<b>150</b> 150	<b>200</b> 200	V
$V_F$	Forward voltage	0.895	0.895	0.895	V
$I_{F(AV)}$	Forward current	8	8	8	A
$t_{tr}$	Reverse recovery time	25	25	25	ns

**PINNING - SOD100**

PIN	DESCRIPTION
1	cathode
2	anode
case	isolated

**PIN CONFIGURATION**

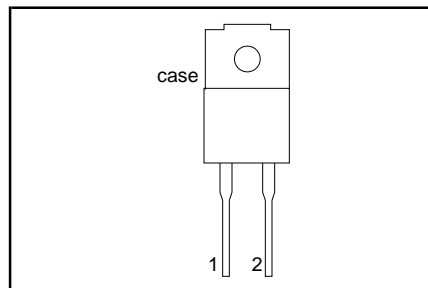

**SYMBOL**

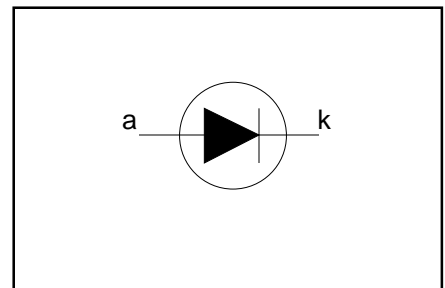

**LIMITING VALUES**

Limiting values in accordance with the Absolute Maximum System (IEC 134).

SYMBOL	PARAMETER	CONDITIONS	MIN.	MAX.			UNIT
				-100	-150	-200	
$V_{RRM}$	Repetitive peak reverse voltage		-	100	150	200	V
$V_{RWM}$	Crest working reverse voltage		-	100	150	200	V
$V_R$	Continuous reverse voltage <sup>1</sup>		-	100	150	200	V
$I_{F(AV)}$	Average forward current <sup>2</sup>	square wave; $\delta = 0.5$ ; $T_{hs} \leq 106^\circ\text{C}$	-	8			A
		sinusoidal; $a = 1.57$ ; $T_{hs} \leq 109^\circ\text{C}$	-	7.3			A
$I_{F(RMS)}$	RMS forward current		-	11.3			A
$I_{FRM}$	Repetitive peak forward current	$t = 25 \mu\text{s}$ ; $\delta = 0.5$ ; $T_{hs} \leq 109^\circ\text{C}$	-	16			A
$I_{FSM}$	Non-repetitive peak forward current	$t = 10 \text{ ms}$	-	80			A
		$t = 8.3 \text{ ms}$ sinusoidal; with reapplied	-	88			A
$I^2t$	$I^2t$ for fusing	$V_{RWM(max)}$ $t = 10 \text{ ms}$	-	32			A <sup>2</sup> s
$T_{stg}$	Storage temperature		-40	150			°C
$T_j$	Operating junction temperature		-	150			°C

1  $T_{hs} \leq 141^\circ\text{C}$  for thermal stability.

2 Neglecting switching and reverse current losses

## Rectifier diodes ultrafast

## BYW29F series

### ISOLATION

$T_{hs} = 25\text{ °C}$  unless otherwise specified

SYMBOL	PARAMETER	CONDITIONS	MIN.	TYP.	MAX.	UNIT
$V_{isol}$	Repetitive peak voltage from both terminals to external heatsink	R.H. $\leq 65\%$ ; clean and dustfree	-	-	1500	V
$C_{isol}$	Capacitance from cathode to external heatsink	$f = 1\text{ MHz}$	-	12	-	pF

### THERMAL RESISTANCES

SYMBOL	PARAMETER	CONDITIONS	MIN.	TYP.	MAX.	UNIT
$R_{th\ j-hs}$	Thermal resistance junction to mounting base	with heatsink compound	-	-	5.5	K/W
$R_{th\ j-a}$	Thermal resistance junction to ambient	without heatsink compound in free air	-	55	7.2	K/W

### STATIC CHARACTERISTICS

$T_j = 25\text{ °C}$  unless otherwise stated

SYMBOL	PARAMETER	CONDITIONS	MIN.	TYP.	MAX.	UNIT
$V_F$	Forward voltage	$I_F = 8\text{ A}$ ; $T_j = 150\text{ °C}$	-	0.80	0.895	V
		$I_F = 8\text{ A}$	-	0.92	1.05	V
		$I_F = 20\text{ A}$	-	1.1	1.3	V
$I_R$	Reverse current	$V_R = V_{RWM}$ ; $T_j = 100\text{ °C}$	-	0.3	0.6	mA
		$V_R = V_{RWM}$	-	2	10	$\mu\text{A}$

### DYNAMIC CHARACTERISTICS

$T_j = 25\text{ °C}$  unless otherwise stated

SYMBOL	PARAMETER	CONDITIONS	MIN.	TYP.	MAX.	UNIT
$Q_s$	Reverse recovery charge	$I_F = 2\text{ A}$ ; $V_R \geq 30\text{ V}$ ; $-di_F/dt = 20\text{ A}/\mu\text{s}$	-	4	11	nC
$t_{rr}$	Reverse recovery time	$I_F = 1\text{ A}$ ; $V_R \geq 30\text{ V}$ ; $-di_F/dt = 100\text{ A}/\mu\text{s}$	-	20	25	ns
$I_{rrm}$	Peak reverse recovery current	$I_F = 10\text{ A}$ ; $V_R \geq 30\text{ V}$ ; $T_j = 100\text{ °C}$ ; $-di_F/dt = 50\text{ A}/\mu\text{s}$	-	1	2	A
$V_{fr}$	Forward recovery voltage	$I_F = 1\text{ A}$ ; $di_F/dt = 10\text{ A}/\mu\text{s}$	-	1	-	V

Rectifier diodes  
ultrafast

BYW29F series

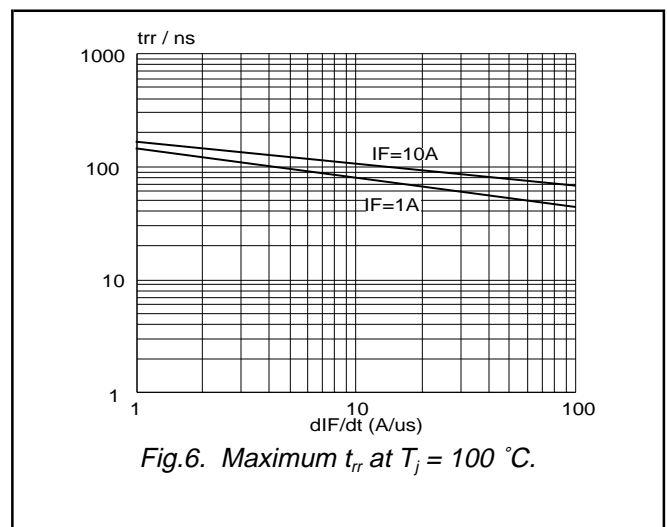
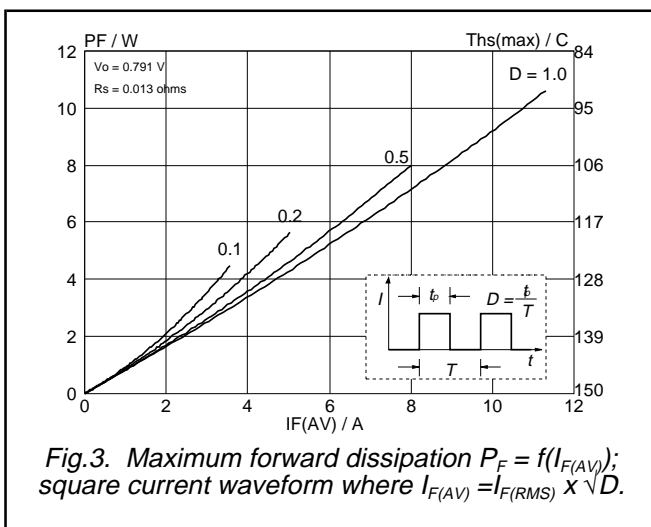
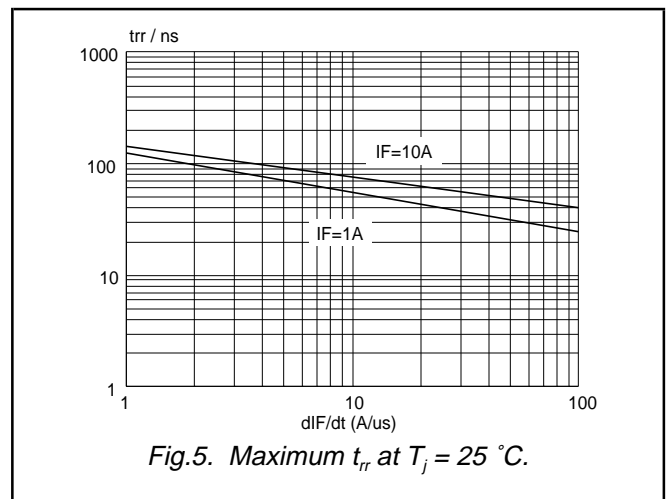
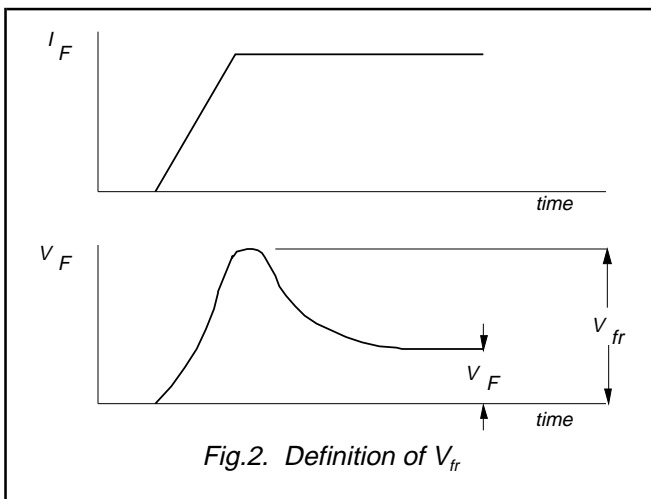
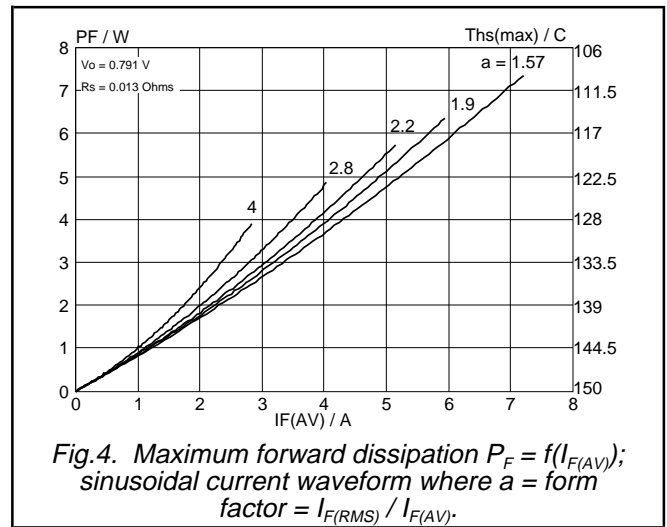
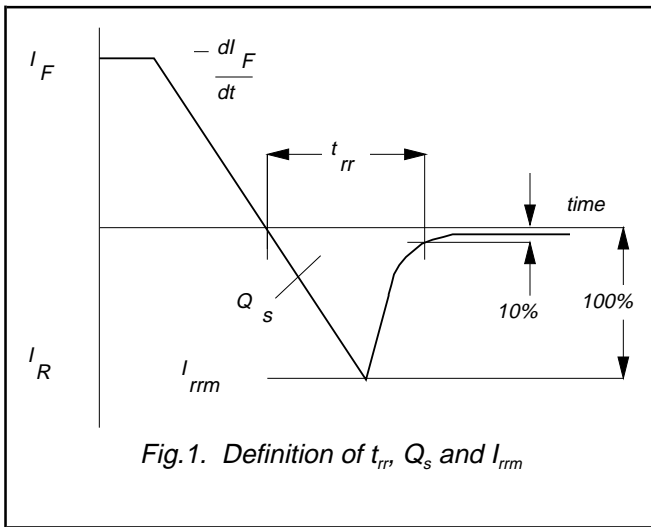

Rectifier diodes  
ultrafast

BYW29F series

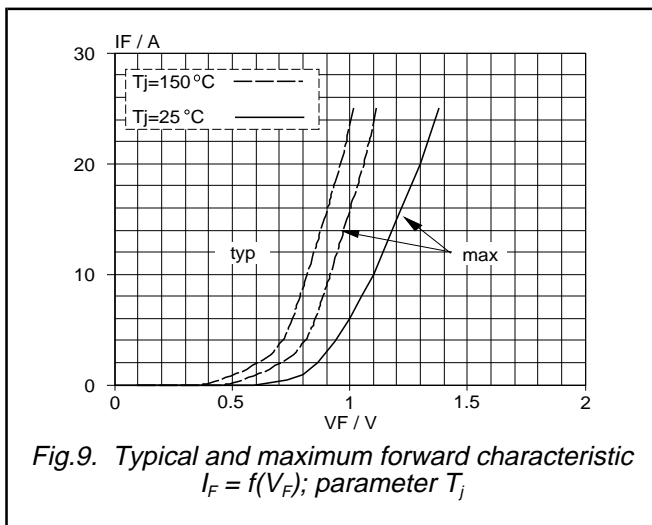
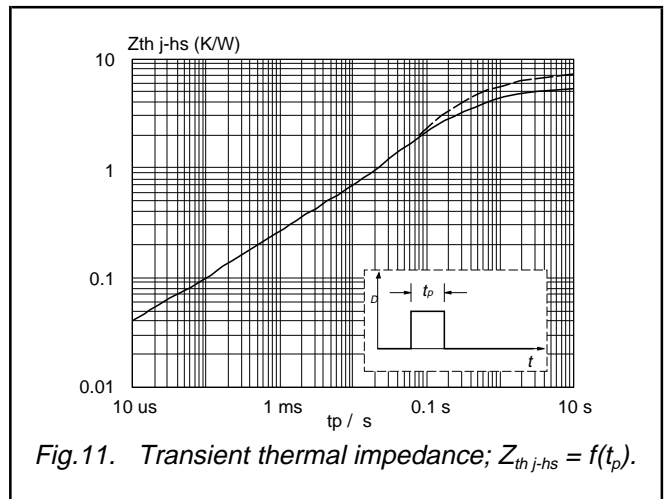
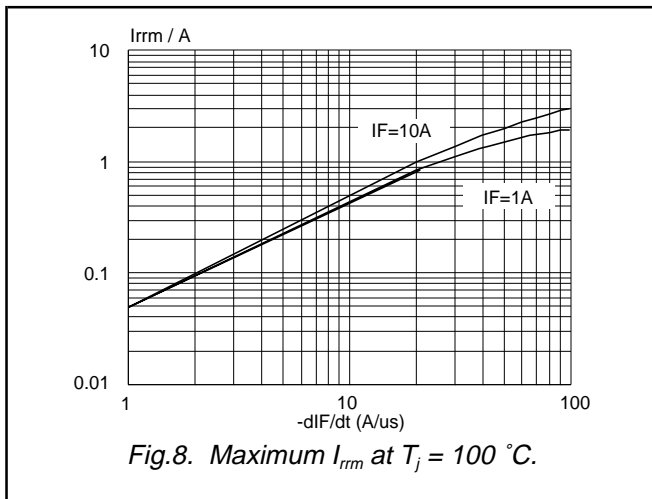
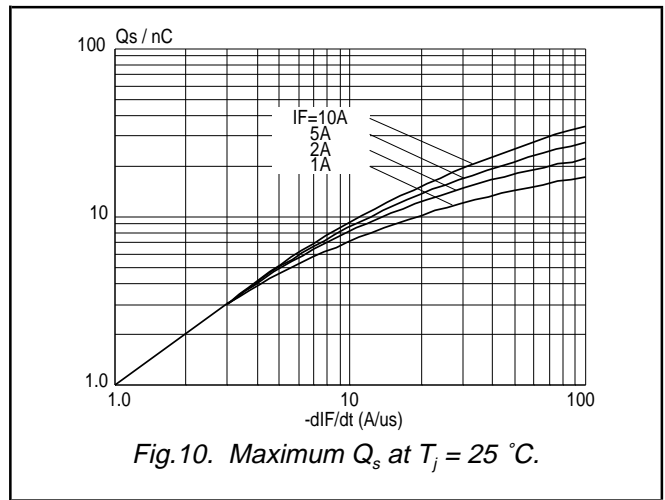
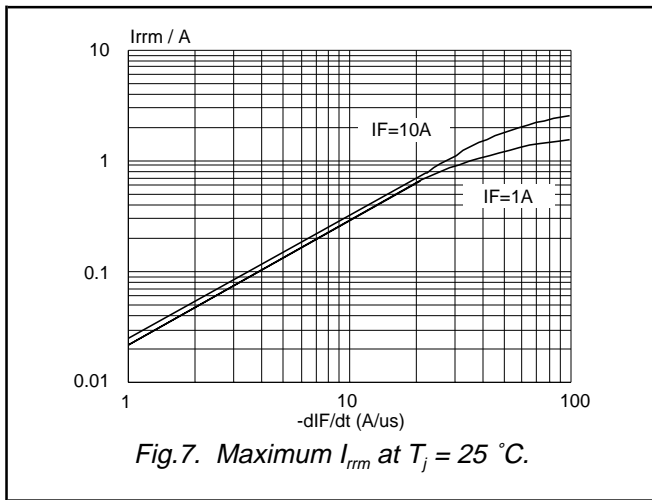

Rectifier diodes  
ultrafast

BYW29F series

**MECHANICAL DATA**

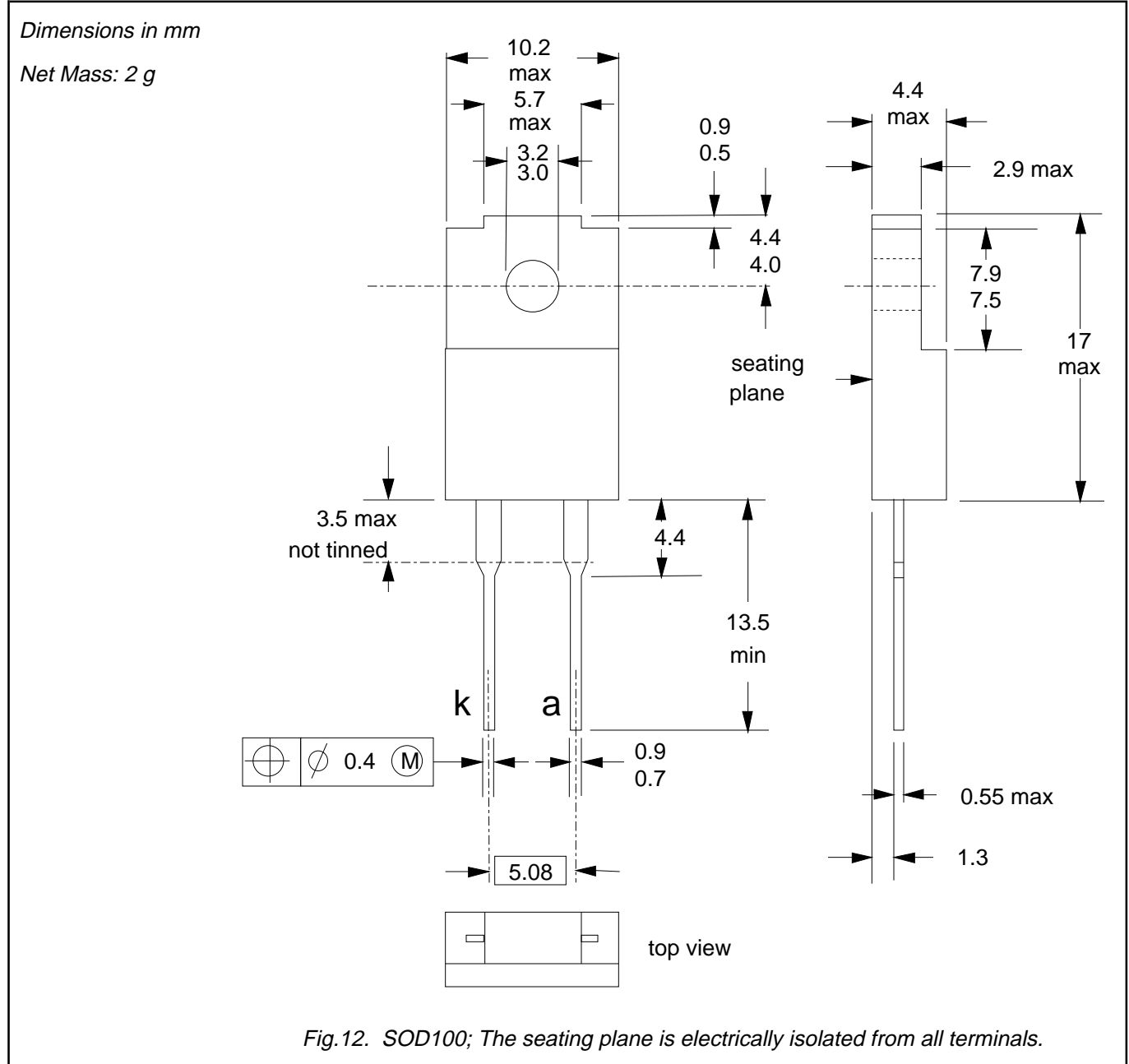

**Notes**

1. Accessories supplied on request: refer to mounting instructions for F-pack envelopes.
2. Epoxy meets UL94 V0 at 1/8".

---

**Rectifier diodes  
ultrafast**

---

**BYW29F series**

---

**DEFINITIONS**

<b>Data sheet status</b>	
Objective specification	This data sheet contains target or goal specifications for product development.
Preliminary specification	This data sheet contains preliminary data; supplementary data may be published later.
Product specification	This data sheet contains final product specifications.
<b>Limiting values</b>	
Limiting values are given in accordance with the Absolute Maximum Rating System (IEC 134). Stress above one or more of the limiting values may cause permanent damage to the device. These are stress ratings only and operation of the device at these or at any other conditions above those given in the Characteristics sections of this specification is not implied. Exposure to limiting values for extended periods may affect device reliability.	
<b>Application information</b>	
Where application information is given, it is advisory and does not form part of the specification.	
© Philips Electronics N.V. 1994	
All rights are reserved. Reproduction in whole or in part is prohibited without the prior written consent of the copyright owner.	
The information presented in this document does not form part of any quotation or contract, it is believed to be accurate and reliable and may be changed without notice. No liability will be accepted by the publisher for any consequence of its use. Publication thereof does not convey nor imply any license under patent or other industrial or intellectual property rights.	

**LIFE SUPPORT APPLICATIONS**

These products are not designed for use in life support appliances, devices or systems where malfunction of these products can be reasonably expected to result in personal injury. Philips customers using or selling these products for use in such applications do so at their own risk and agree to fully indemnify Philips for any damages resulting from such improper use or sale.