

# DATA SHEET

## **BGY204** UHF amplifier module

Product specification  
File under Discrete Semiconductors, SC09

1996 May 21

# UHF amplifier module

# BGY204

### FEATURES

- 4.8 V nominal supply voltage
- 3.2 W output power
- Easy control of output power by DC voltage.

### APPLICATIONS

- Digital cellular radio systems with Time Division Multiple Access (TDMA) operation (GSM systems) in the 880 to 915 MHz frequency range.

### DESCRIPTION

The BGY204 is a four-stage UHF amplifier module in a SOT321B package. The module consists of four NPN silicon planar transistor dies mounted together with matching and bias circuit components on a metallized ceramic substrate.

### PINNING - SOT321B

PIN	DESCRIPTION
1	RF input
2	V <sub>C</sub>
3	V <sub>S</sub>
4	RF output
Flange	ground

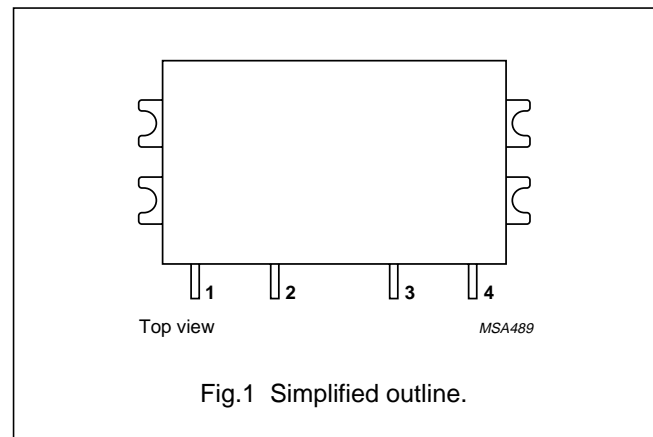

### QUICK REFERENCE DATA

RF performance at T<sub>mb</sub> = 25 °C.

MODE OF OPERATION	f (MHz)	V <sub>S</sub> (V)	V <sub>C</sub> (V)	P <sub>L</sub> (W)	G <sub>p</sub> (dB)	η (%)	Z <sub>S</sub> ; Z <sub>L</sub> (Ω)
Pulsed; δ = 1 : 8	880 to 915	4.8	≤3.5	3.2	≥35	typ. 45	50

## UHF amplifier module

## BGY204

**LIMITING VALUES**

In accordance with the Absolute Maximum Rating System (IEC 134).

SYMBOL	PARAMETER	CONDITIONS	MIN.	MAX.	UNIT
$V_S$	DC supply voltage	$P_L = 0$	–	8	V
$V_C$	DC control voltage		–	4.5	V
$P_D$	input drive power		–	2	mW
$P_L$	load power	$V_S \leq 6.5$ V; $Z_L = 50$ $\Omega$	–	4	W
$T_{stg}$	storage temperature		–40	+100	°C
$T_{mb}$	operating mounting base temperature		–30	+100	°C

**CHARACTERISTICS**

$Z_S = Z_L = 50$   $\Omega$ ;  $P_D = 1$  mW;  $V_S = 4.8$  V;  $V_C \leq 3.5$  V;  $f = 880$  to 915 MHz;  $T_{mb} = 25$  °C;  $\delta = 1 : 8$ ;  $t_p = 575$   $\mu$ s; unless otherwise specified.

SYMBOL	PARAMETER	CONDITIONS	MIN.	TYP.	MAX.	UNIT
$I_Q$	leakage current	$V_C = 0.5$ V	–	–	0.2	mA
$I_C$	control current	adjust $V_C$ for $P_L = 3.2$ W	–	–	0.5	mA
$P_L$	load power		3.2	–	–	W
$G_p$	power gain	adjust $V_C$ for $P_L = 3.2$ W	35	–	–	dB
$\eta$	efficiency	adjust $V_C$ for $P_L = 3.2$ W	40	45	–	%
$H_2$	second harmonic	adjust $V_C$ for $P_L = 3.2$ W	–	–	–40	dBc
$H_3$	third harmonic	adjust $V_C$ for $P_L = 3.2$ W	–	–	–40	dBc
$V_{SWR}_{in}$	input VSWR	adjust $V_C$ for $P_L = 3.2$ W	–	–	2.5 : 1	
	stability	$P_D = 0.5$ to 2 mW; $V_S = 4$ to 6.5 V; $V_C = 0$ to 3.5 V; $P_L \leq 3.2$ W; $V_{SWR} \leq 6 : 1$ through all phases;	–	–	–60	dBc
	isolation	$V_C = 0.5$ V	–	–	–36	dBm
	control bandwidth		1	–	–	MHz
$P_n$	noise power	$P_L = 3.2$ W; bandwidth = 30 kHz; 20 MHz above transmitter band	–	–	–85	dBm
	ruggedness	$V_S = 6.5$ V; adjust $V_C$ for $P_L = 3.2$ W; $V_{SWR} \leq 10 : 1$ through all phases	no degradation			

UHF amplifier module

BGY204

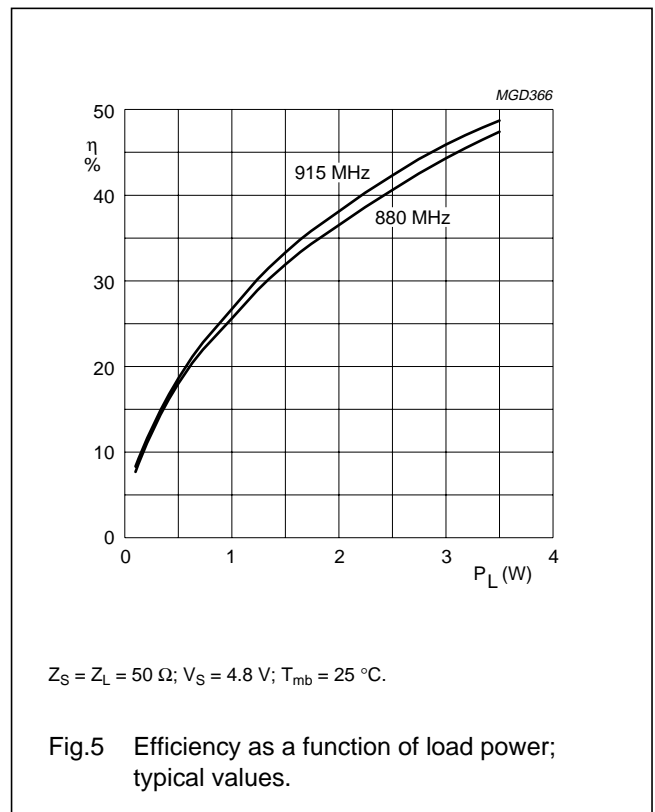
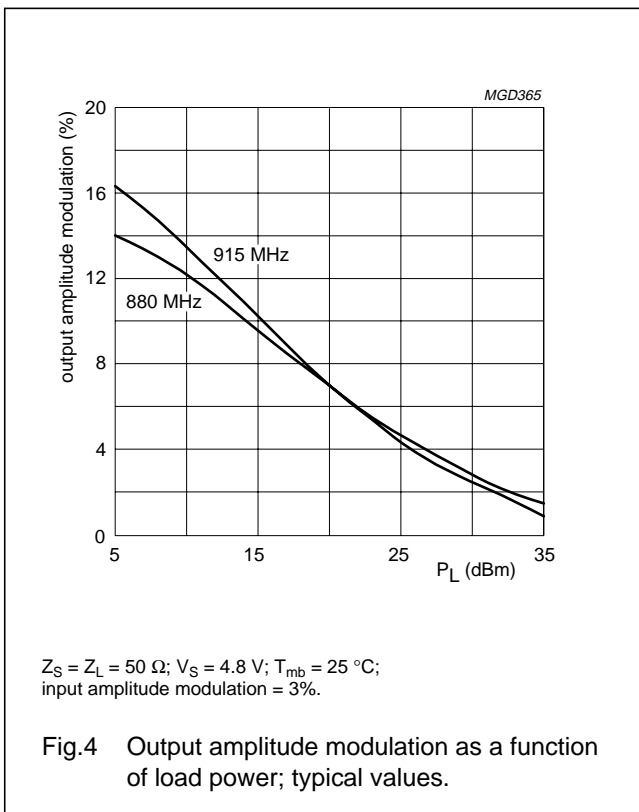
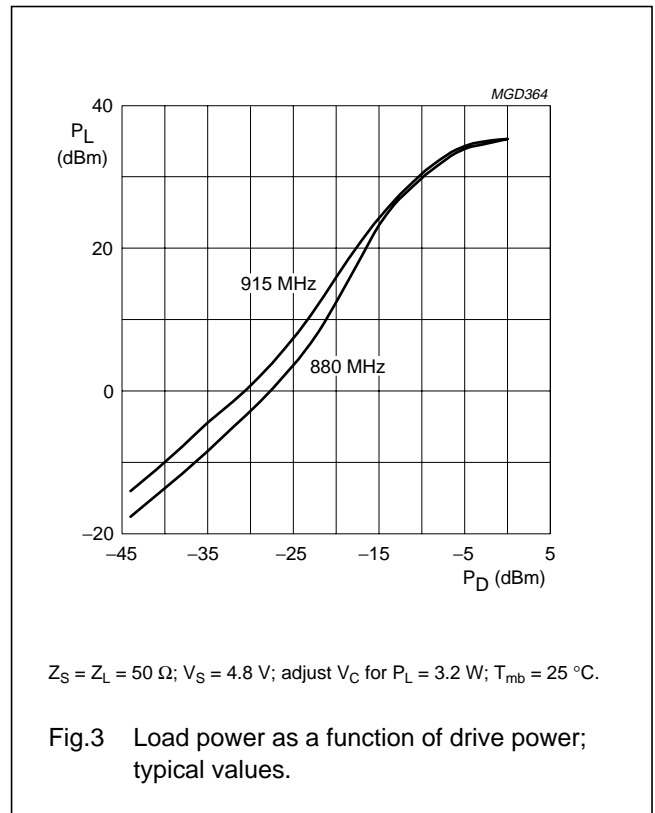
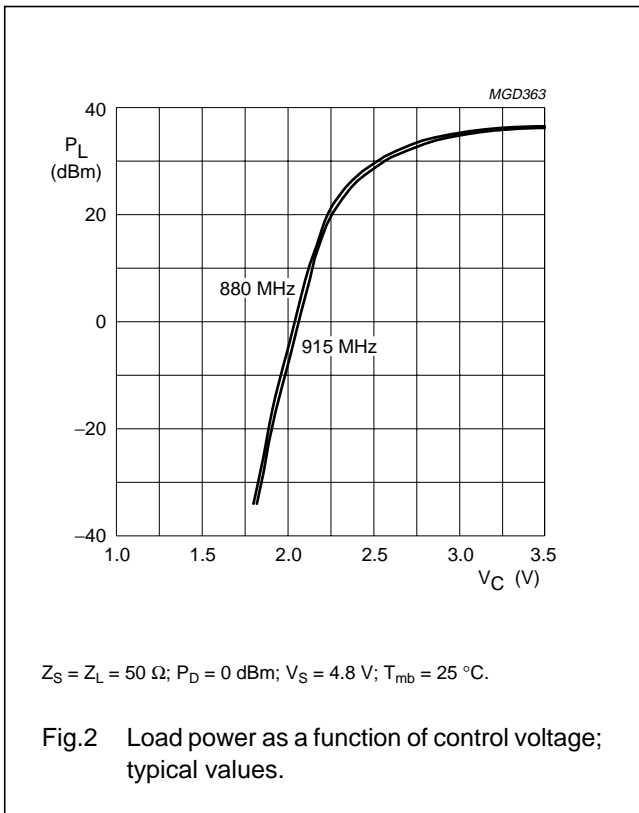

UHF amplifier module

BGY204

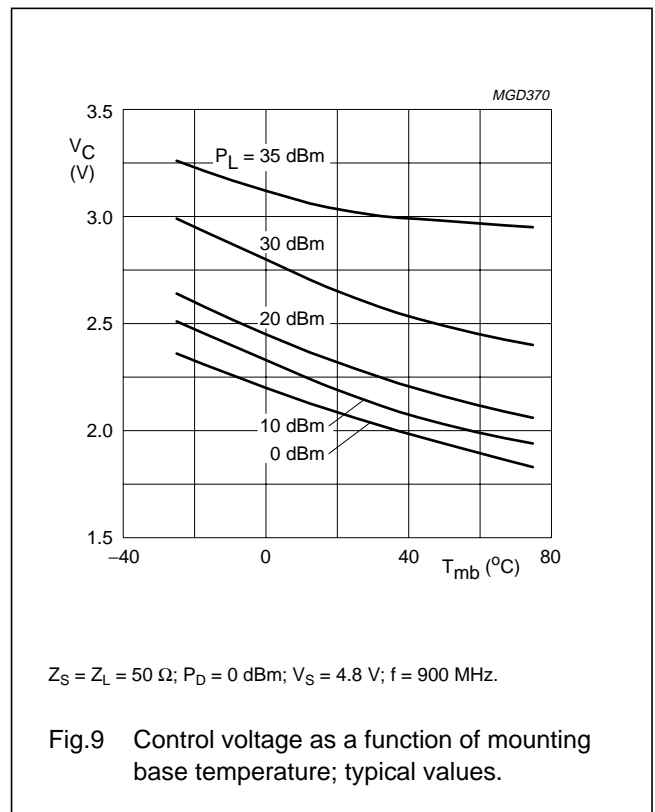
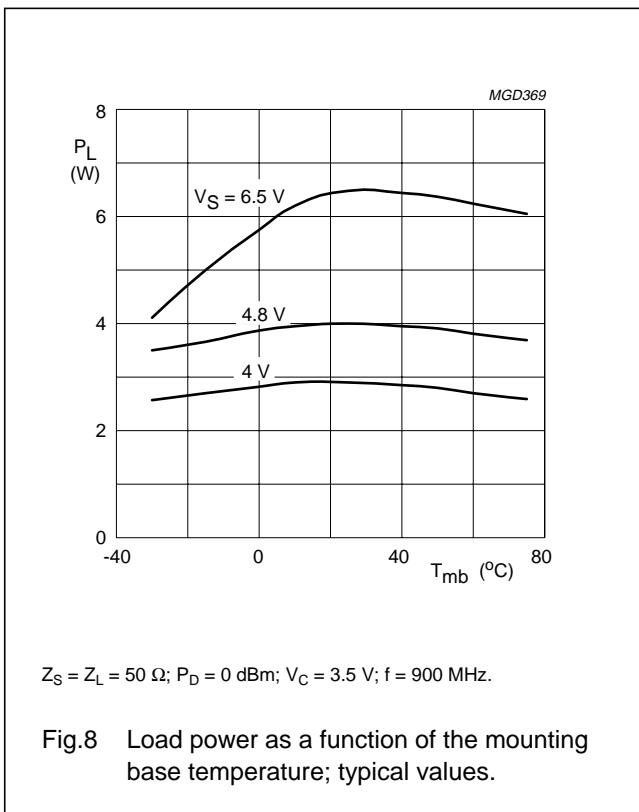
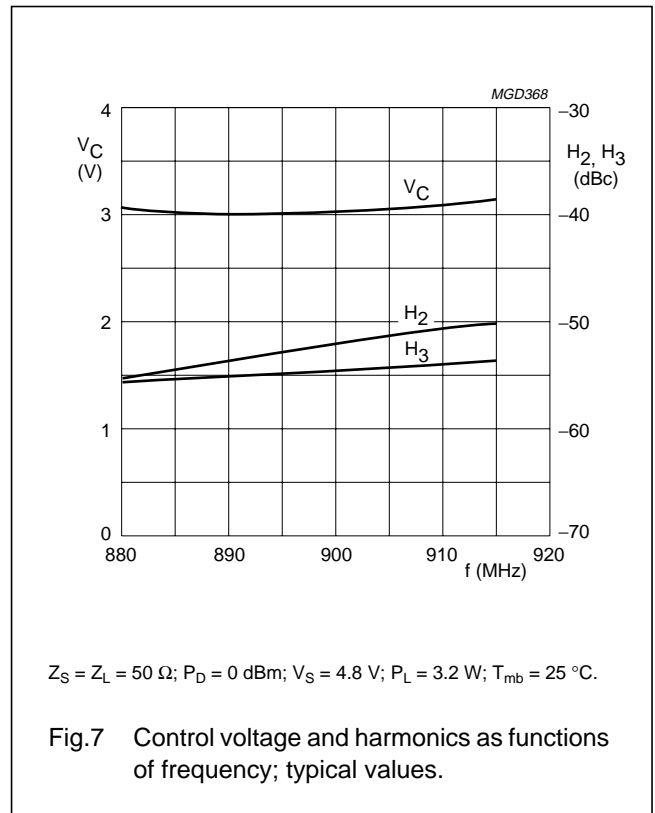
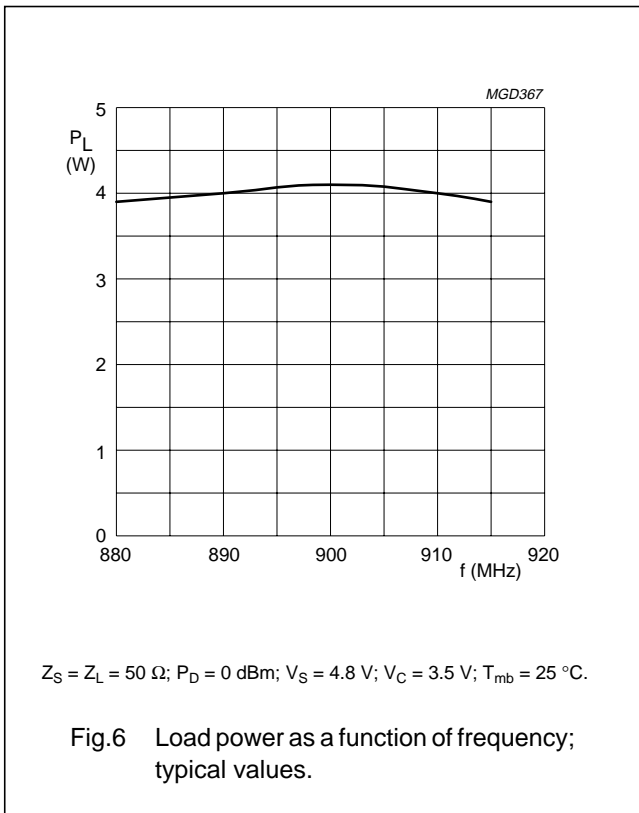

UHF amplifier module

BGY204

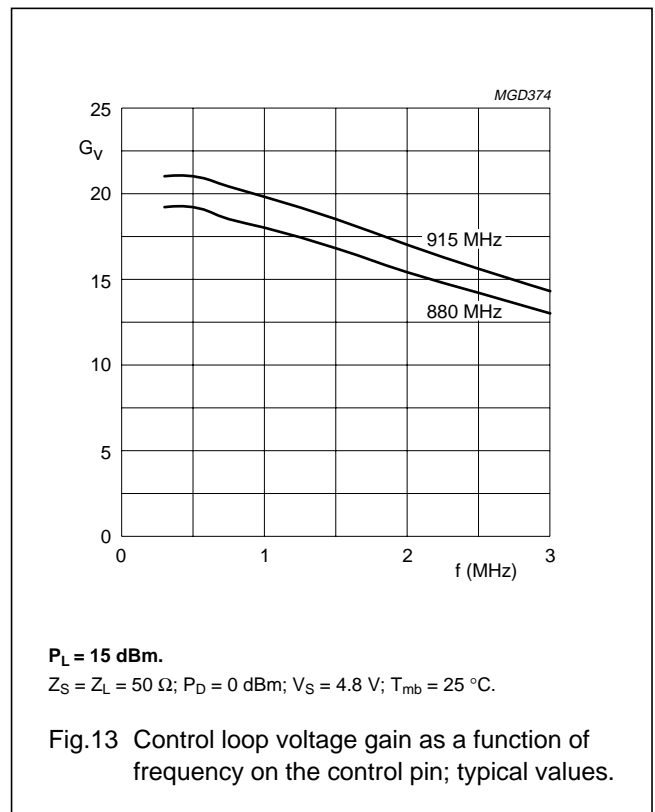
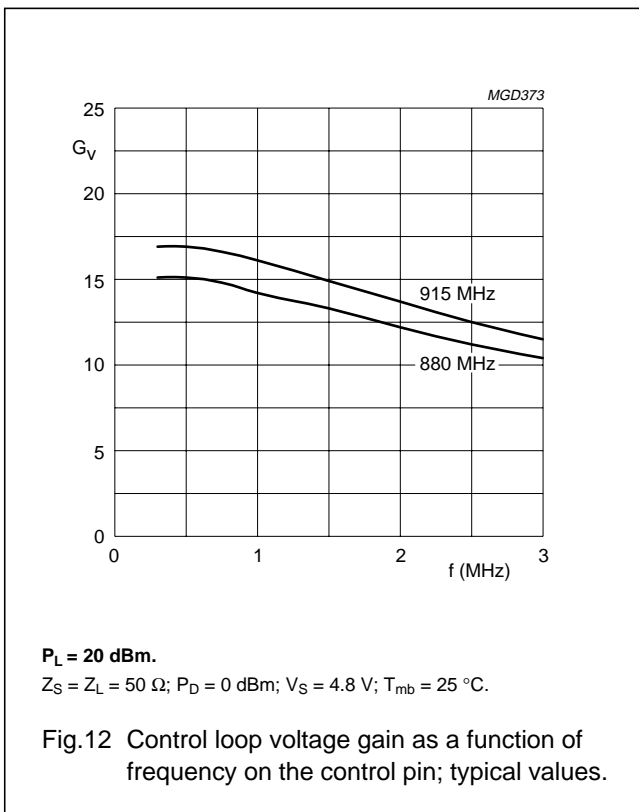
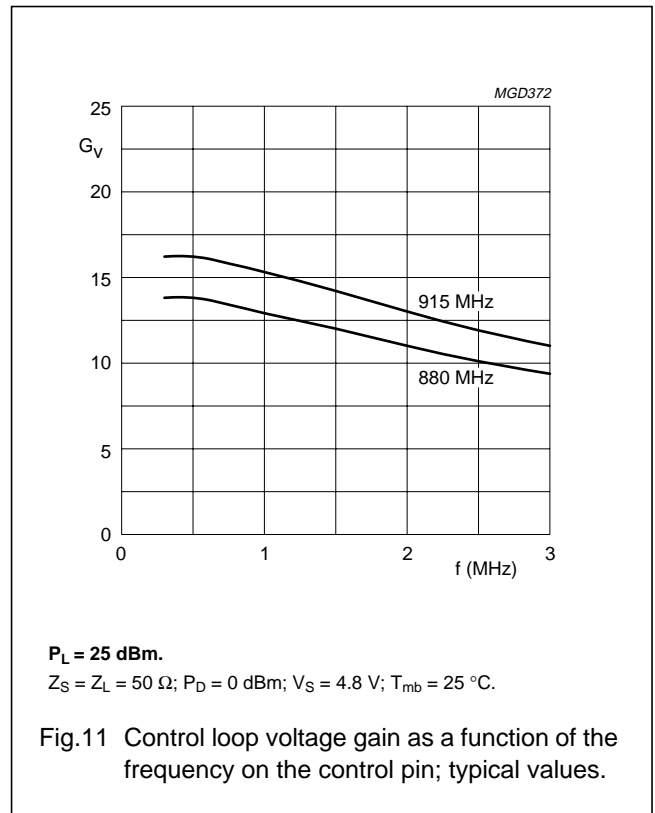
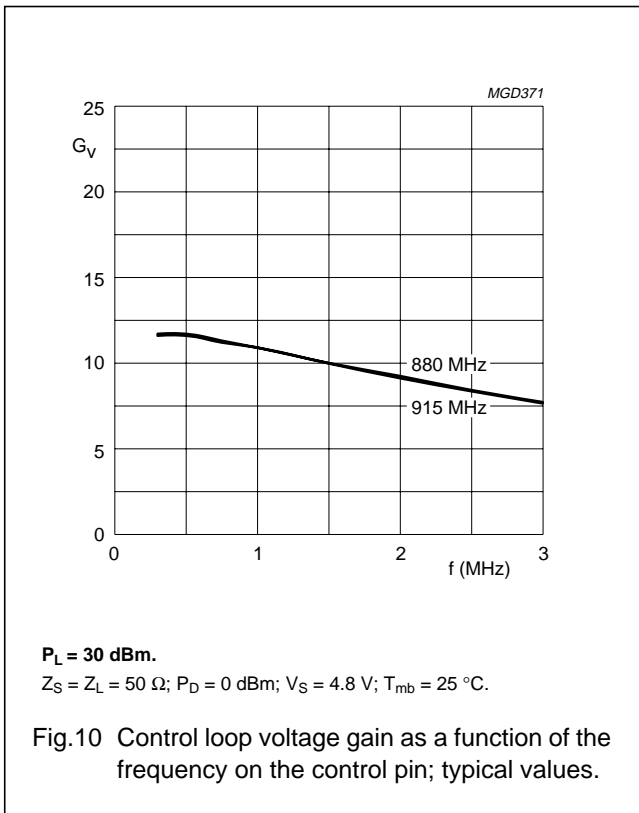

UHF amplifier module

BGY204

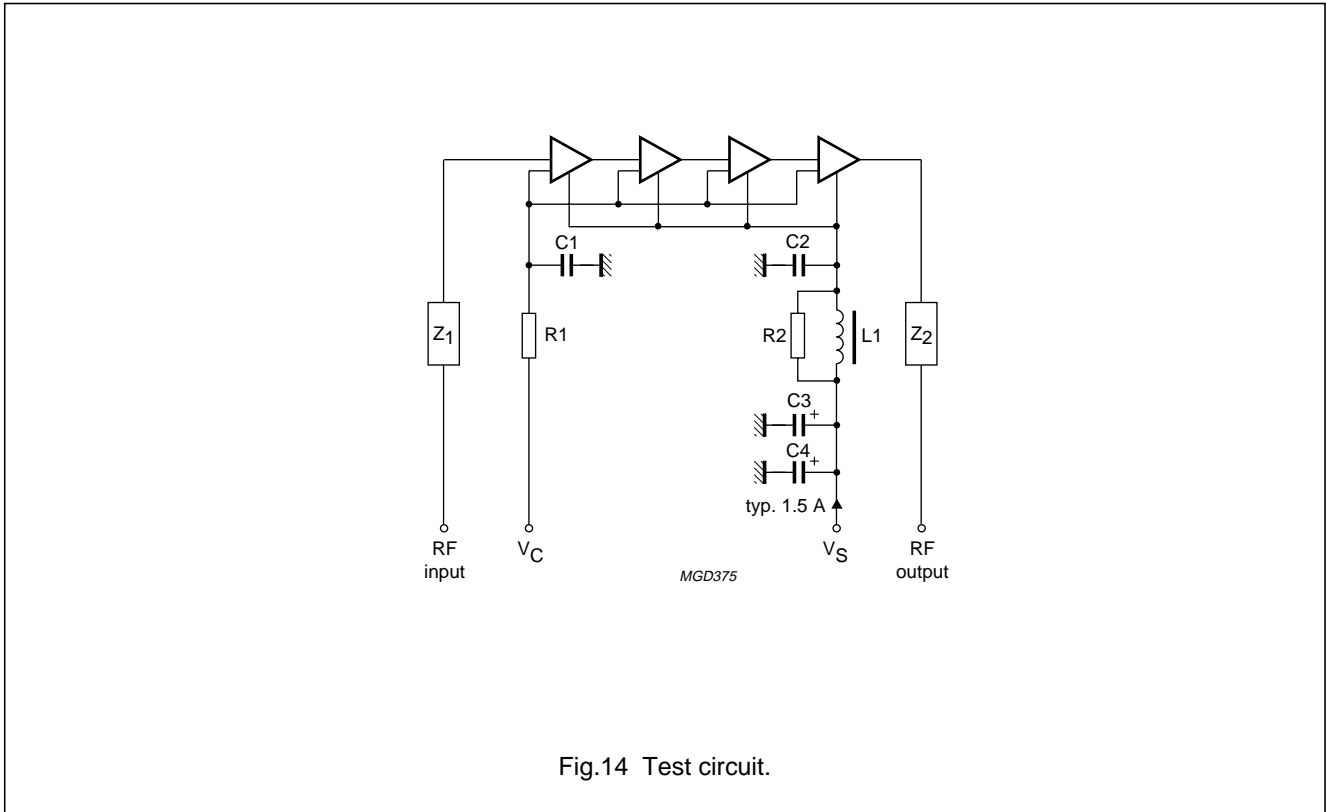
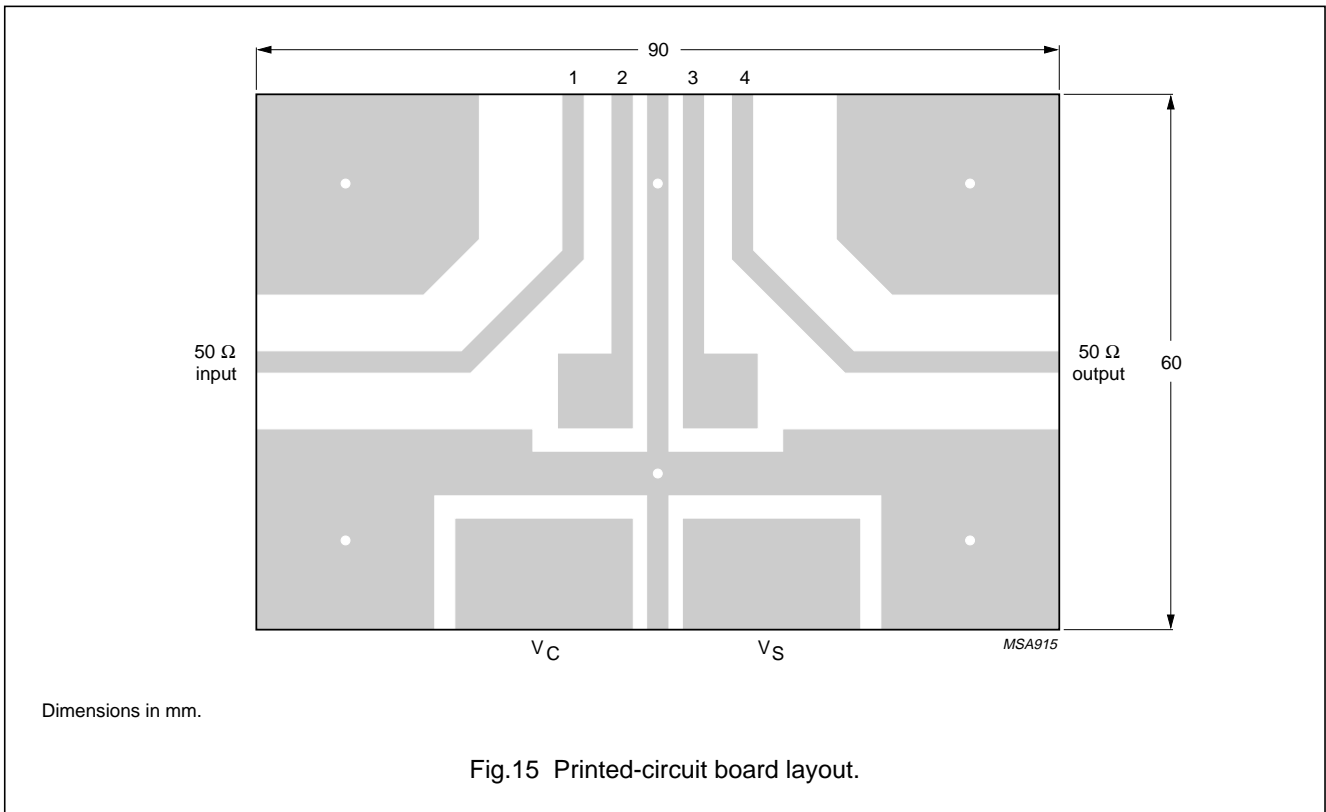

Fig.14 Test circuit.



Dimensions in mm.

Fig.15 Printed-circuit board layout.

## UHF amplifier module

BGY204

## List of components (See Fig.14)

COMPONENT	DESCRIPTION	VALUE	CATALOGUE NO.
C1, C2	multilayer ceramic chip capacitor	680 pF	–
C3	tantalum capacitor	2.2 $\mu$ F; 35 V	–
C4	electrolytic capacitor	47 $\mu$ F; 40 V	–
L1	Grade 3B Ferroxcube bead		4330 030 36300
Z <sub>1</sub> , Z <sub>2</sub>	stripline; note 1	50 $\Omega$	–
R1	metal film resistor	100 $\Omega$ ; 0.4 W	–
R2	metal film resistor	5 $\Omega$ ; 0.4 W	–

**Note**

1. The striplines are on a double copper-clad printed-circuit board with PTFE fibreglass dielectric ( $\epsilon_r = 2.2$ ); thickness  $\frac{1}{16}$  inch.



## UHF amplifier module

## BGY204

**SOLDERING**

The indicated temperatures are those at the solder interfaces.

Advised solder types are types with a liquidus less than or equal to 210 °C.

Solder dots or solder prints must be large enough to wet the contact areas.

Footprints for soldering should cover the module contact area +0.1 mm on all sides.

Soldering can be carried out using a conveyor oven, a hot air oven, an infrared oven or a combination of these ovens.

Hand soldering must be avoided because the soldering iron tip can exceed the maximum permitted temperature of 250 °C and damage the module.

The maximum temperature profile and soldering time is indicated as follows (see Fig.16):

t = 350 s at 100 °C

t = 300 s at 125 °C

t = 200 s at 150 °C

t = 100 s at 175 °C

t = 50 s at 200 °C

t = 5 s at 250 °C (maximum temperature).

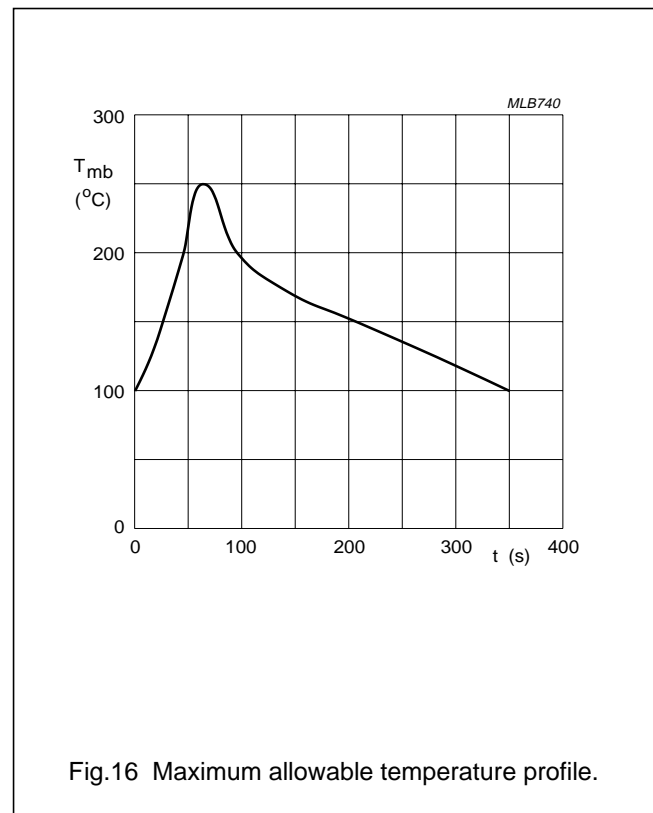

Fig.16 Maximum allowable temperature profile.

**Cleaning**

The following fluids may be used for cleaning:

- Alcohol
- Bio-Act (Terpene Hydrocarbon)
- Triclean B/S
- Acetone.

Ultrasonic cleaning should not be used since this can cause serious damage to the product.

UHF amplifier module

BGY204

PACKAGE OUTLINE

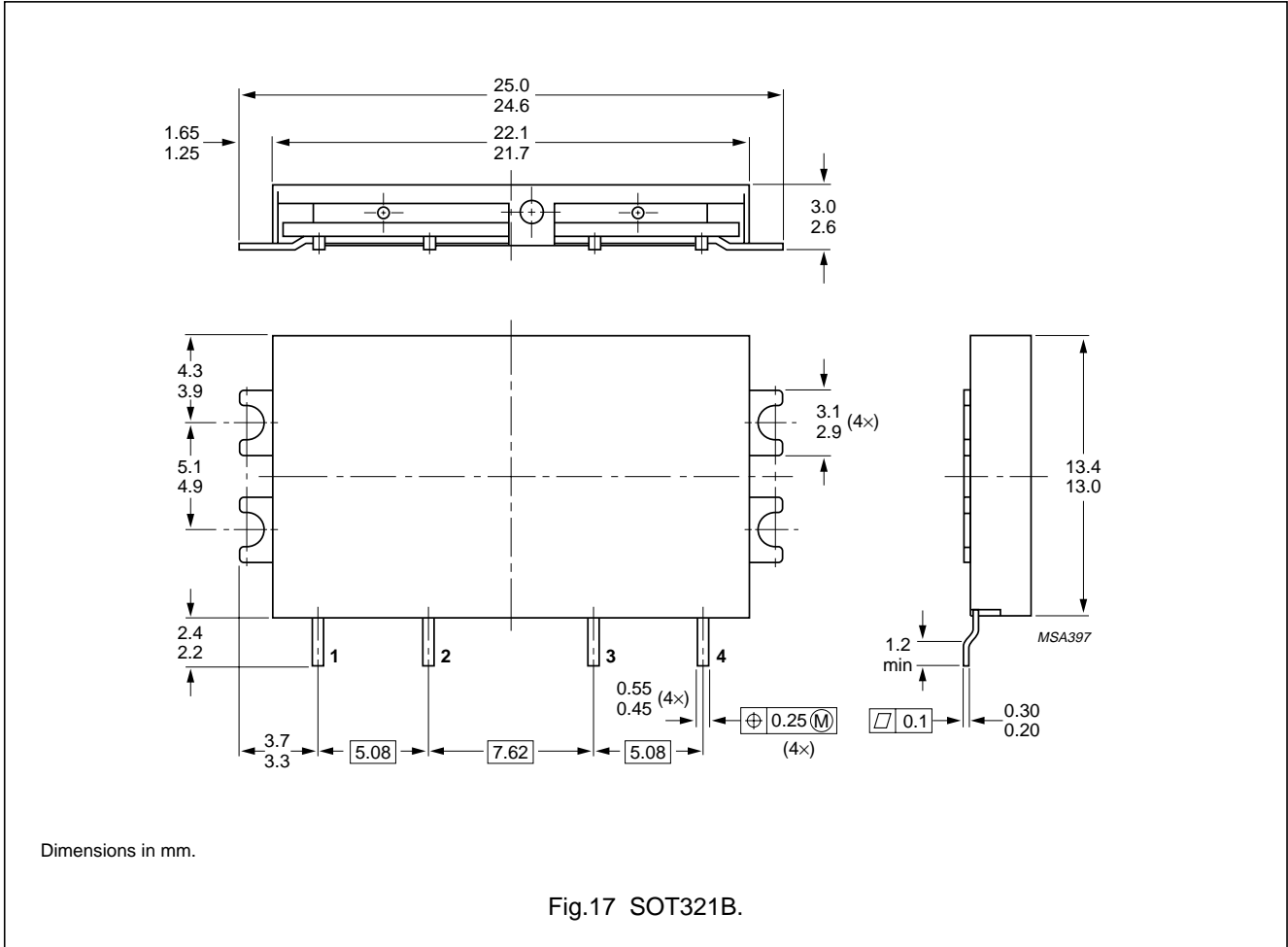

## UHF amplifier module

BGY204

**DEFINITIONS**

<b>Data sheet status</b>	
Objective specification	This data sheet contains target or goal specifications for product development.
Preliminary specification	This data sheet contains preliminary data; supplementary data may be published later.
Product specification	This data sheet contains final product specifications.
<b>Limiting values</b>	
Limiting values given are in accordance with the Absolute Maximum Rating System (IEC 134). Stress above one or more of the limiting values may cause permanent damage to the device. These are stress ratings only and operation of the device at these or at any other conditions above those given in the Characteristics sections of the specification is not implied. Exposure to limiting values for extended periods may affect device reliability.	
<b>Application information</b>	
Where application information is given, it is advisory and does not form part of the specification.	

**LIFE SUPPORT APPLICATIONS**

These products are not designed for use in life support appliances, devices, or systems where malfunction of these products can reasonably be expected to result in personal injury. Philips customers using or selling these products for use in such applications do so at their own risk and agree to fully indemnify Philips for any damages resulting from such improper use or sale.