

Features

- Advanced Process Technology
- Key Parameters Optimized for Class-D Audio Amplifier Applications
- Low $R_{DS(ON)}$ for Improved Efficiency
- Low Q_g and Q_{sw} for Better THD and Improved Efficiency
- Low Q_{rr} for Better THD and Lower EMI
- 175°C Operating Junction Temperature for Ruggedness
- Repetitive Avalanche Capability for Robustness and Reliability
- Multiple Package Options

Key Parameters		
V_{DS}	-55	V
$R_{DS(ON)}$ typ. @ $V_{GS} = -10V$	93	mΩ
$R_{DS(ON)}$ typ. @ $V_{GS} = -4.5V$	150	mΩ
Q_g typ.	31	nC
T_J max	175	°C

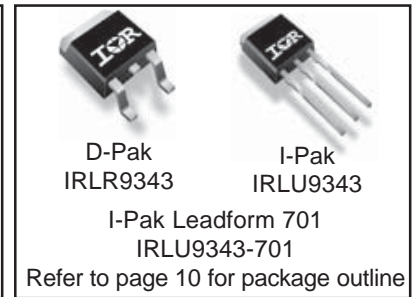
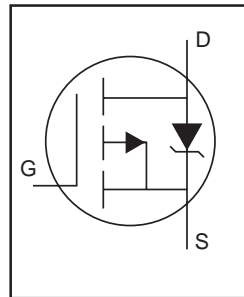

Description

This Digital Audio HEXFET[®] is specifically designed for Class-D audio amplifier applications. This MosFET utilizes the latest processing techniques to achieve low on-resistance per silicon area. Furthermore, Gate charge, body-diode reverse recovery and internal Gate resistance are optimized to improve key Class-D audio amplifier performance factors such as efficiency, THD and EMI. Additional features of this MosFET are 175°C operating junction temperature and repetitive avalanche capability. These features combine to make this MosFET a highly efficient, robust and reliable device for Class-D audio amplifier applications.

Absolute Maximum Ratings

	Parameter	Max.	Units
V_{DS}	Drain-to-Source Voltage	-55	V
V_{GS}	Gate-to-Source Voltage	±20	
I_D @ $T_C = 25^\circ C$	Continuous Drain Current, V_{GS} @ -10V	-20	A
I_D @ $T_C = 100^\circ C$	Continuous Drain Current, V_{GS} @ 10V	-14	
I_{DM}	Pulsed Drain Current ①	-60	
P_D @ $T_C = 25^\circ C$	Power Dissipation	79	W
P_D @ $T_C = 100^\circ C$	Power Dissipation	39	
	Linear Derating Factor	0.53	W/°C
T_J	Operating Junction and	-40 to + 175	°C
T_{STG}	Storage Temperature Range		
	Clamping Pressure ⑥	—	N

Thermal Resistance

	Parameter	Typ.	Max.	Units
$R_{\theta JC}$	Junction-to-Case ⑤	—	1.9	°C/W
$R_{\theta JA}$	Junction-to-Ambient (PCB Mounted) ⑤⑧	—	50	
$R_{\theta JA}$	Junction-to-Ambient (free air) ⑤	—	110	

Notes ① through ⑧ are on page 10

Electrical Characteristics @ $T_J = 25^\circ\text{C}$ (unless otherwise specified)

	Parameter	Min.	Typ.	Max.	Units	Conditions
BV_{DSS}	Drain-to-Source Breakdown Voltage	-55	—	—	V	$V_{GS} = 0V, I_D = -250\mu A$
$\Delta BV_{DSS}/\Delta T_J$	Breakdown Voltage Temp. Coefficient	—	-52	—	mV/°C	Reference to $25^\circ\text{C}, I_D = -1mA$
$R_{DS(on)}$	Static Drain-to-Source On-Resistance	—	93	105	mΩ	$V_{GS} = -10V, I_D = -3.4A$ ③
		—	150	170		$V_{GS} = -4.5V, I_D = -2.7A$ ③
$V_{GS(th)}$	Gate Threshold Voltage	-1.0	—	—	V	$V_{DS} = V_{GS}, I_D = -250\mu A$
$\Delta V_{GS(th)}/\Delta T_J$	Gate Threshold Voltage Coefficient	—	-3.7	—	mV/°C	
I_{DSS}	Drain-to-Source Leakage Current	—	—	-2.0	μA	$V_{DS} = -55V, V_{GS} = 0V$
		—	—	-25		$V_{DS} = -55V, V_{GS} = 0V, T_J = 125^\circ\text{C}$
I_{GSS}	Gate-to-Source Forward Leakage	—	—	-100	nA	$V_{GS} = -20V$
	Gate-to-Source Reverse Leakage	—	—	100		$V_{GS} = 20V$
g_{fs}	Forward Transconductance	5.3	—	—	S	$V_{DS} = -25V, I_D = -14A$
Q_g	Total Gate Charge	—	31	47		$V_{DS} = -44V$
Q_{gs}	Gate-to-Source Charge	—	7.1	—		$V_{GS} = -10V$
Q_{gd}	Gate-to-Drain Charge	—	8.5	—		$I_D = -14A$
Q_{godr}	Gate Charge Overdrive	—	15	—		See Fig. 6 and 19
$t_{d(on)}$	Turn-On Delay Time	—	9.5	—	ns	$V_{DD} = -28V, V_{GS} = -10V$ ③
t_r	Rise Time	—	24	—		$I_D = -14A$
$t_{d(off)}$	Turn-Off Delay Time	—	21	—		$R_G = 2.5\Omega$
t_f	Fall Time	—	9.5	—		
C_{iss}	Input Capacitance	—	660	—	pF	$V_{GS} = 0V$
C_{oss}	Output Capacitance	—	160	—		$V_{DS} = -50V$
C_{rss}	Reverse Transfer Capacitance	—	72	—		$f = 1.0MHz,$ See Fig.5
C_{oss}	Effective Output Capacitance	—	280	—		$V_{GS} = 0V, V_{DS} = 0V$ to $-44V$
L_D	Internal Drain Inductance	—	4.5	—	nH	Between lead, 6mm (0.25in.)
L_S	Internal Source Inductance	—	7.5	—		from package and center of die contact ④

Avalanche Characteristics

	Parameter	Typ.	Max.	Units
E_{AS}	Single Pulse Avalanche Energy ②	—	120	mJ
I_{AR}	Avalanche Current ⑦	See Fig. 14, 15, 17a, 17b		A
E_{AR}	Repetitive Avalanche Energy ⑦			mJ

Diode Characteristics

	Parameter	Min.	Typ.	Max.	Units	Conditions
$I_S @ T_C = 25^\circ\text{C}$	Continuous Source Current (Body Diode)	—	—	-20	A	MOSFET symbol showing the integral reverse p-n junction diode.
I_{SM}	Pulsed Source Current (Body Diode) ①	—	—	-60		
V_{SD}	Diode Forward Voltage	—	—	-1.2	V	$T_J = 25^\circ\text{C}, I_S = -14A, V_{GS} = 0V$ ③
t_{rr}	Reverse Recovery Time	—	57	86	ns	$T_J = 25^\circ\text{C}, I_F = -14A$
Q_{rr}	Reverse Recovery Charge	—	120	180	nC	$di/dt = 100A/\mu s$ ③

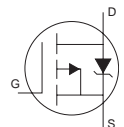

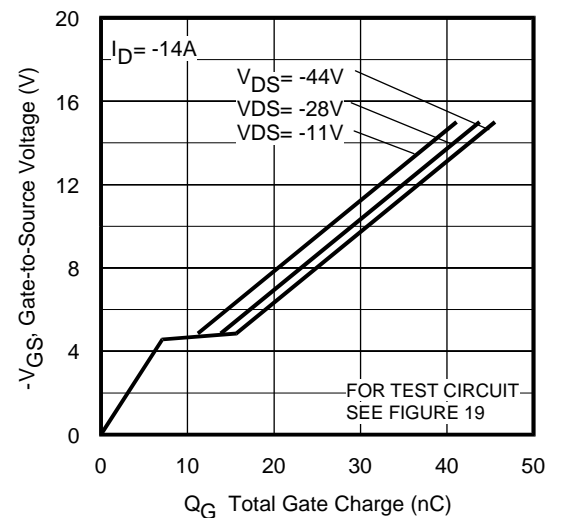
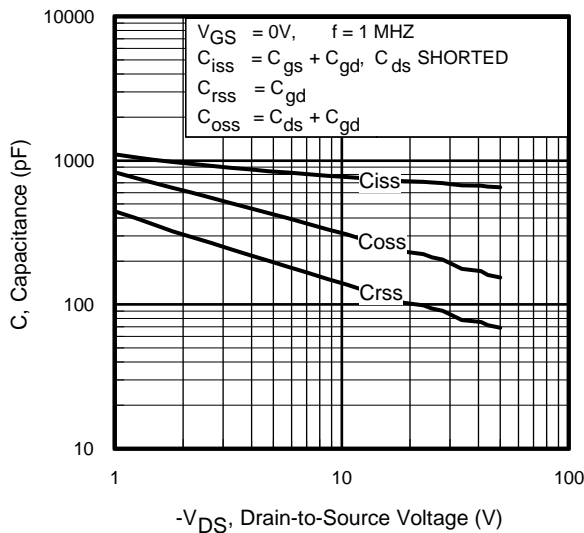
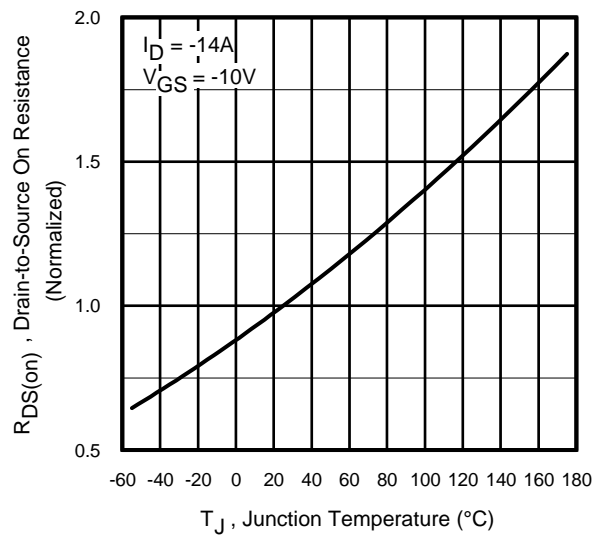
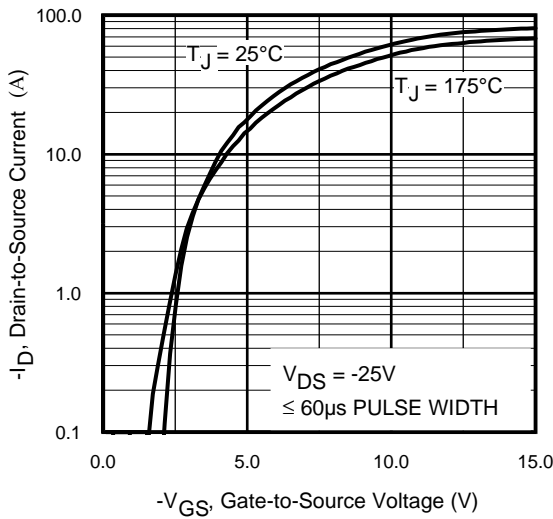
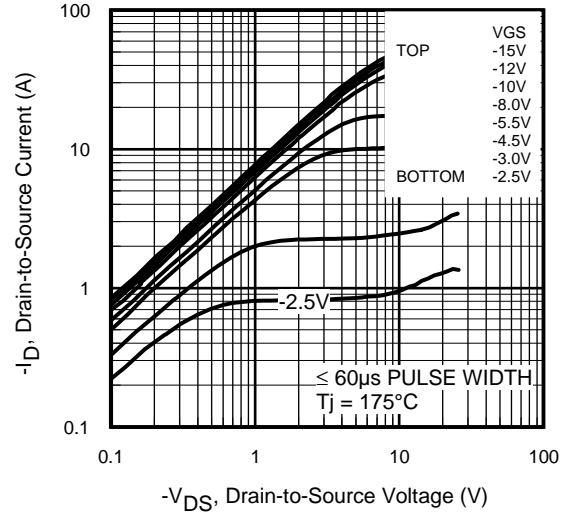
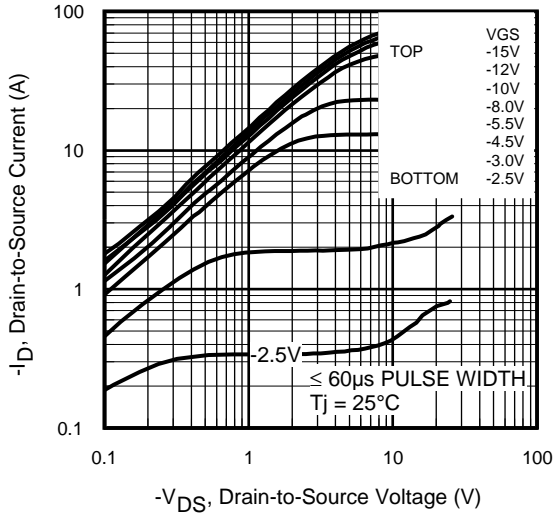

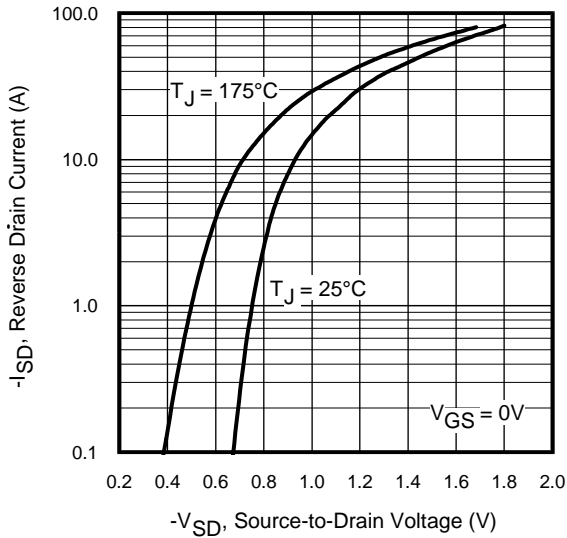

Fig 7. Typical Source-Drain Diode Forward Voltage

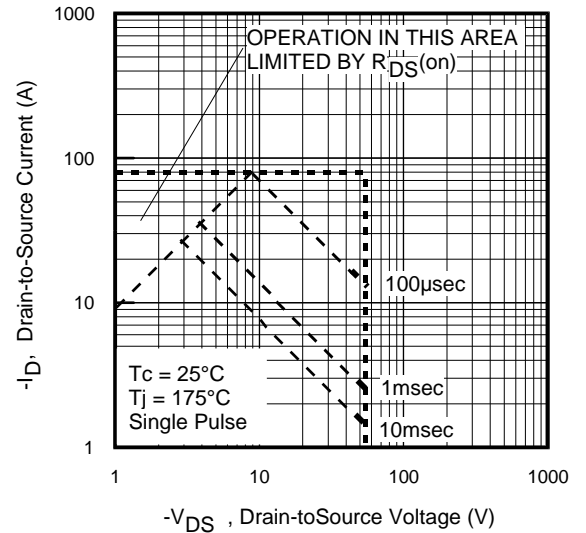

Fig 8. Maximum Safe Operating Area

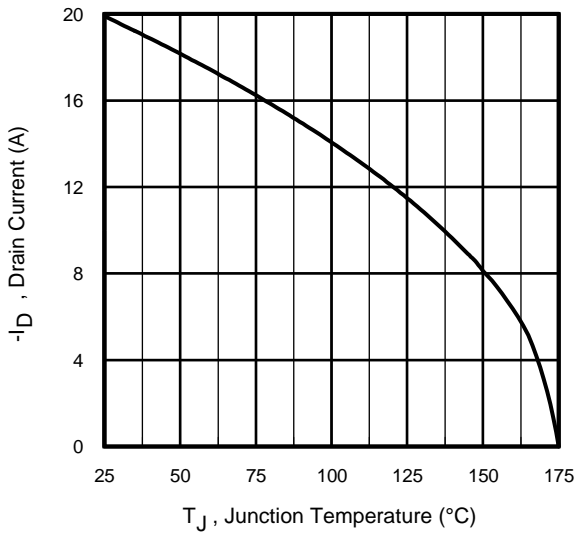

Fig 9. Maximum Drain Current vs. Case Temperature

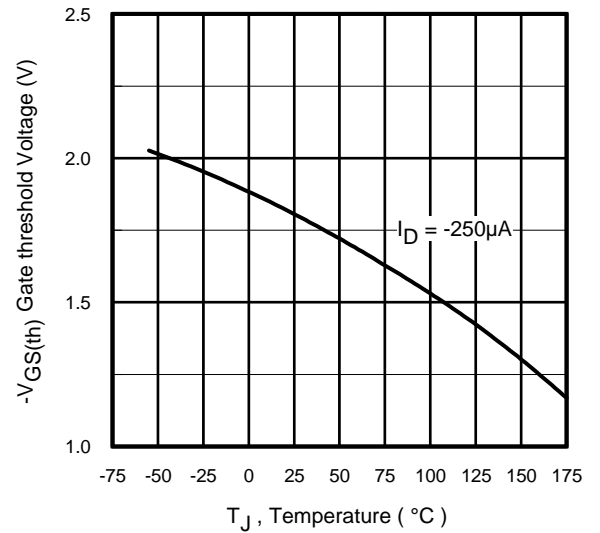

Fig 10. Threshold Voltage vs. Temperature

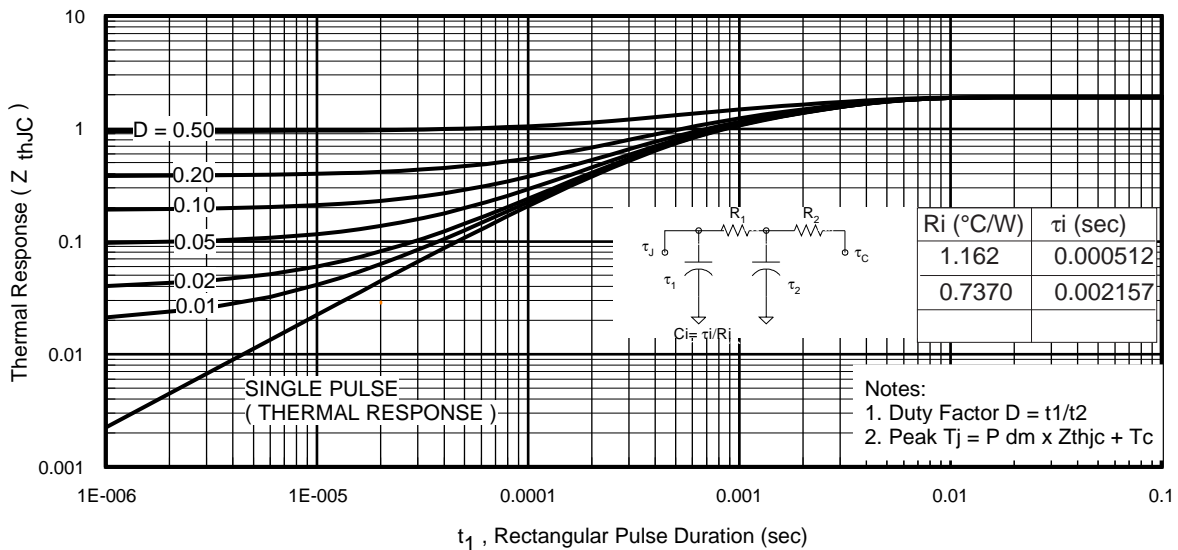

Fig 11. Maximum Effective Transient Thermal Impedance, Junction-to-Case

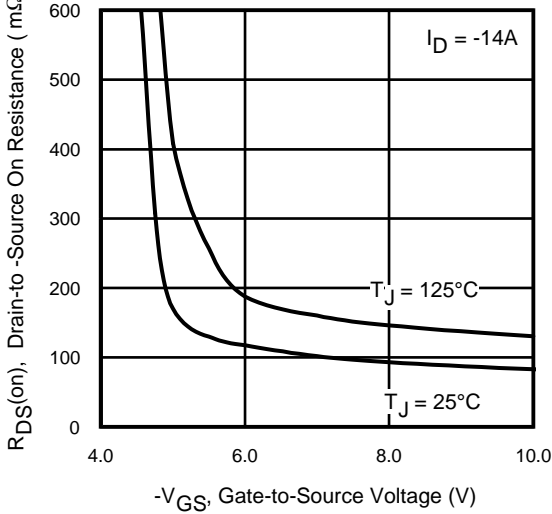

Fig 12. On-Resistance Vs. Gate Voltage

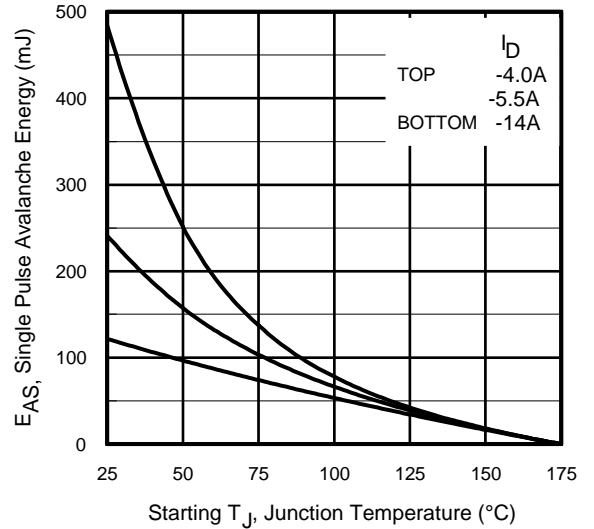

Fig 13. Maximum Avalanche Energy Vs. Drain Current

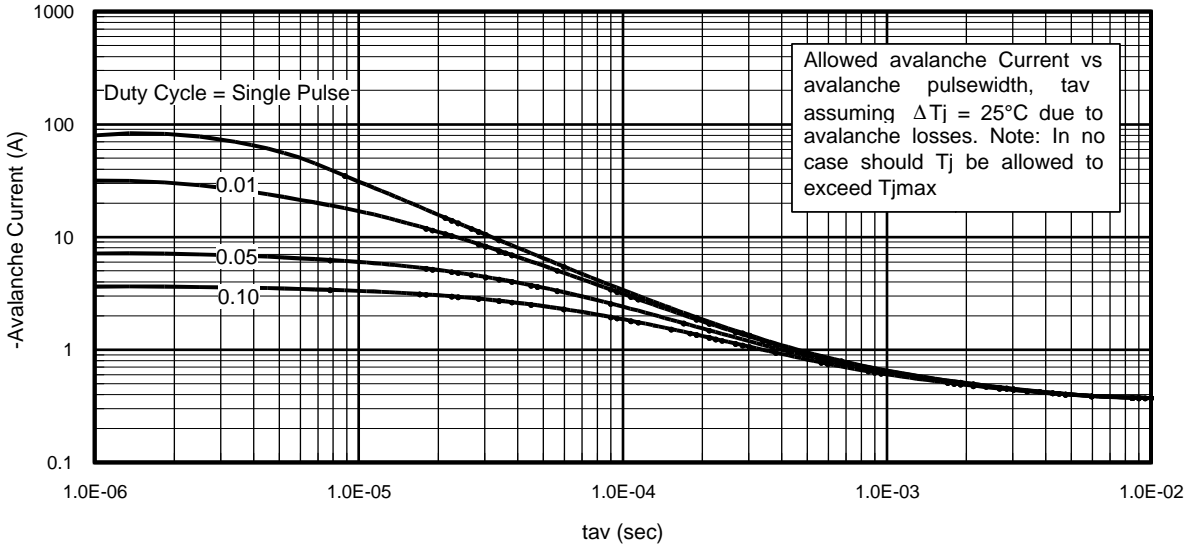

Fig 14. Typical Avalanche Current Vs. Pulsewidth

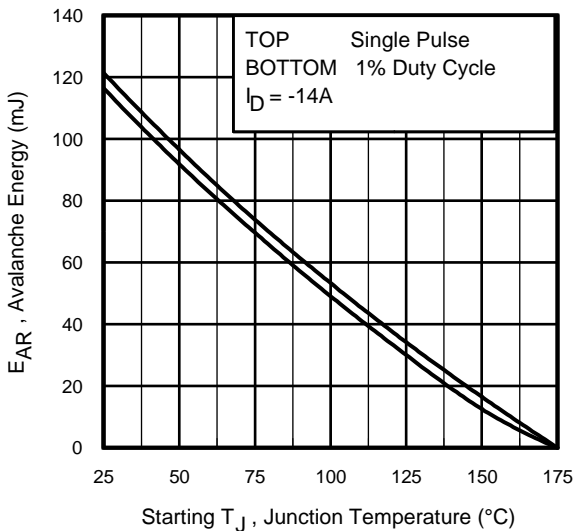

Fig 15. Maximum Avalanche Energy Vs. Temperature

Notes on Repetitive Avalanche Curves , Figures 14, 15:
(For further info, see AN-1005 at www.irf.com)

1. Avalanche failures assumption:
Purely a thermal phenomenon and failure occurs at a temperature far in excess of T_{jmax} . This is validated for every part type.
2. Safe operation in Avalanche is allowed as long as T_{jmax} is not exceeded.
3. Equation below based on circuit and waveforms shown in Figures 17a, 17b.
4. $P_{D(ave)}$ = Average power dissipation per single avalanche pulse.
5. BV = Rated breakdown voltage (1.3 factor accounts for voltage increase during avalanche).
6. I_{av} = Allowable avalanche current.
7. ΔT = Allowable rise in junction temperature, not to exceed T_{jmax} (assumed as 25°C in Figure 14, 15).
 t_{av} = Average time in avalanche
 D = Duty cycle in avalanche = $t_{av} \cdot f$
 $Z_{thJC}(D, t_{av})$ = Transient thermal resistance, see figure 11)

$$P_{D(ave)} = 1/2 (1.3 \cdot BV \cdot I_{av}) = \Delta T / Z_{thJC}$$

$$I_{av} = 2\Delta T / [1.3 \cdot BV \cdot Z_{thJC}]$$

$$E_{AS(AR)} = P_{D(ave)} \cdot t_{av}$$

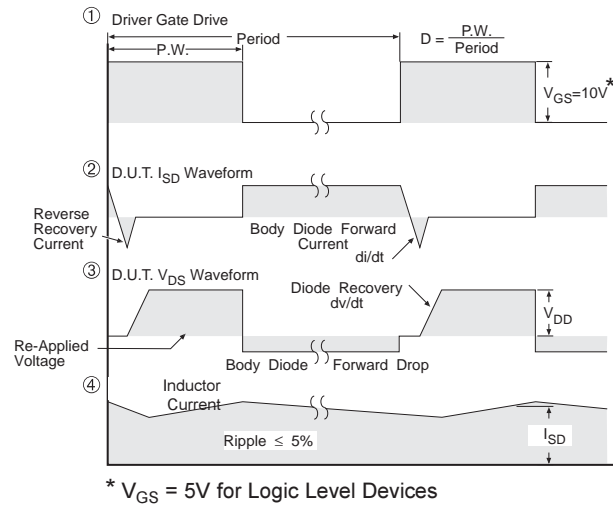
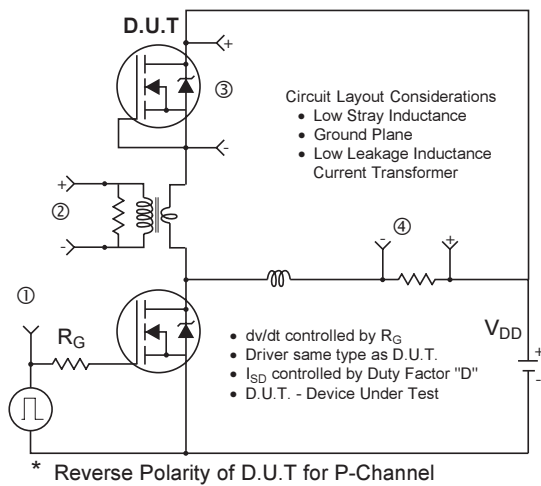

Fig 16. Peak Diode Recovery dv/dt Test Circuit for P-Channel HEXFET® Power MOSFETs

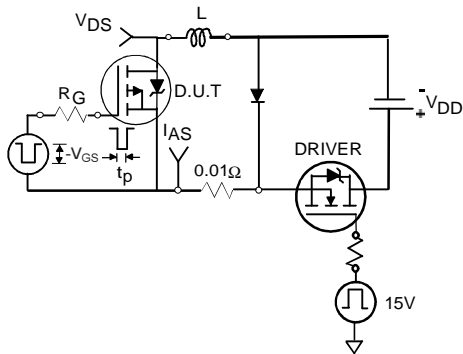

Fig 17a. Unclamped Inductive Test Circuit

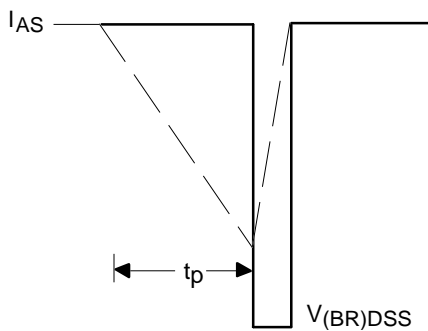

Fig 17b. Unclamped Inductive Waveforms

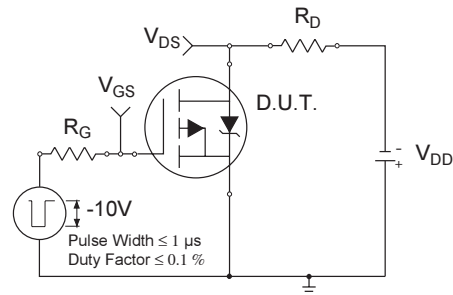

Fig 18a. Switching Time Test Circuit

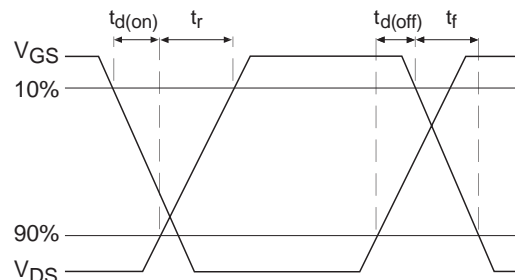

Fig 18b. Switching Time Waveforms

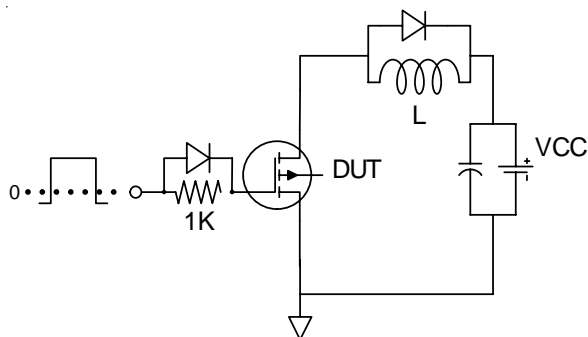

Fig 19a. Gate Charge Test Circuit

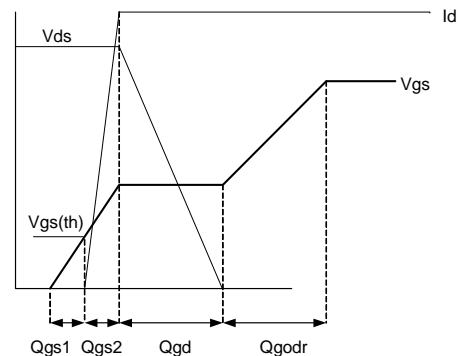
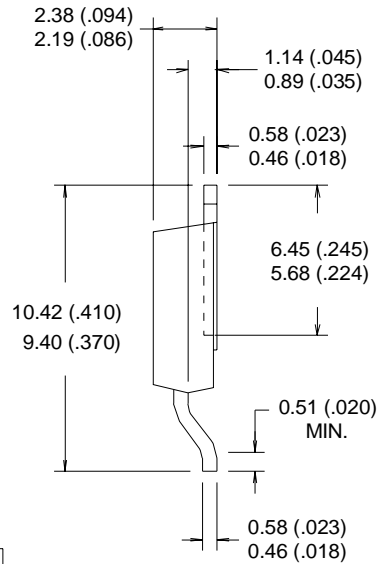
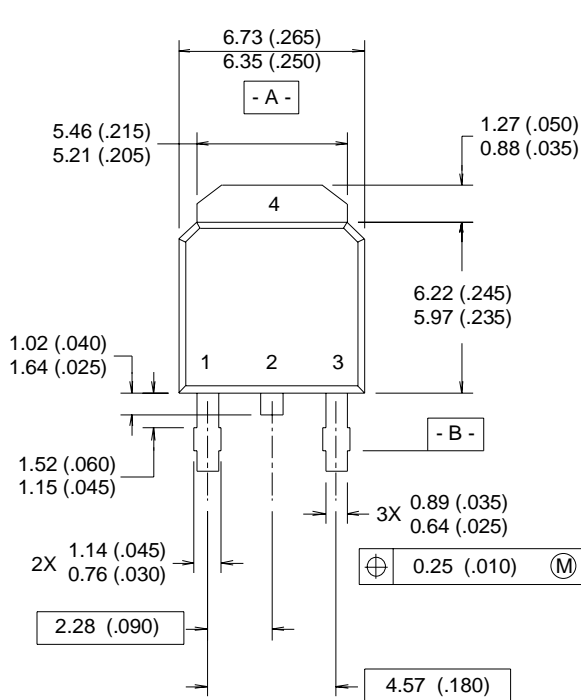

Fig 19b Gate Charge Waveform

D-Pak (TO-252AA) Package Outline

Dimensions are shown in millimeters (inches)



LEAD ASSIGNMENTS

- 1 - GATE
- 2 - DRAIN
- 3 - SOURCE
- 4 - DRAIN

NOTES:

- 1 DIMENSIONING & TOLERANCING PER ANSI Y14.5M, 1982.
- 2 CONTROLLING DIMENSION : INCH.
- 3 CONFORMS TO JEDEC OUTLINE TO-252AA.
- 4 DIMENSIONS SHOWN ARE BEFORE SOLDER DIP, SOLDER DIP MAX. +0.16 (.006).

D-Pak (TO-252AA) Part Marking Information

Notes: This part marking information applies to devices produced before 02/26/2001

EXAMPLE: THIS IS AN IRFR120
WITH ASSEMBLY
LOT CODE 9U1P

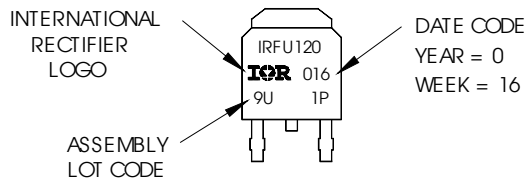

Notes: This part marking information applies to devices produced after 02/26/2001

EXAMPLE: THIS IS AN IRFR120
WITH ASSEMBLY
LOT CODE 1234
ASSEMBLED ON WW 16, 1999
IN THE ASSEMBLY LINE "A"

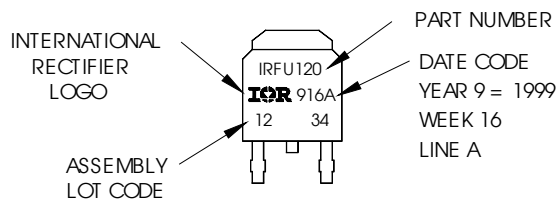

I-Pak (TO-251AA) Package Outline

Dimensions are shown in millimeters (inches)

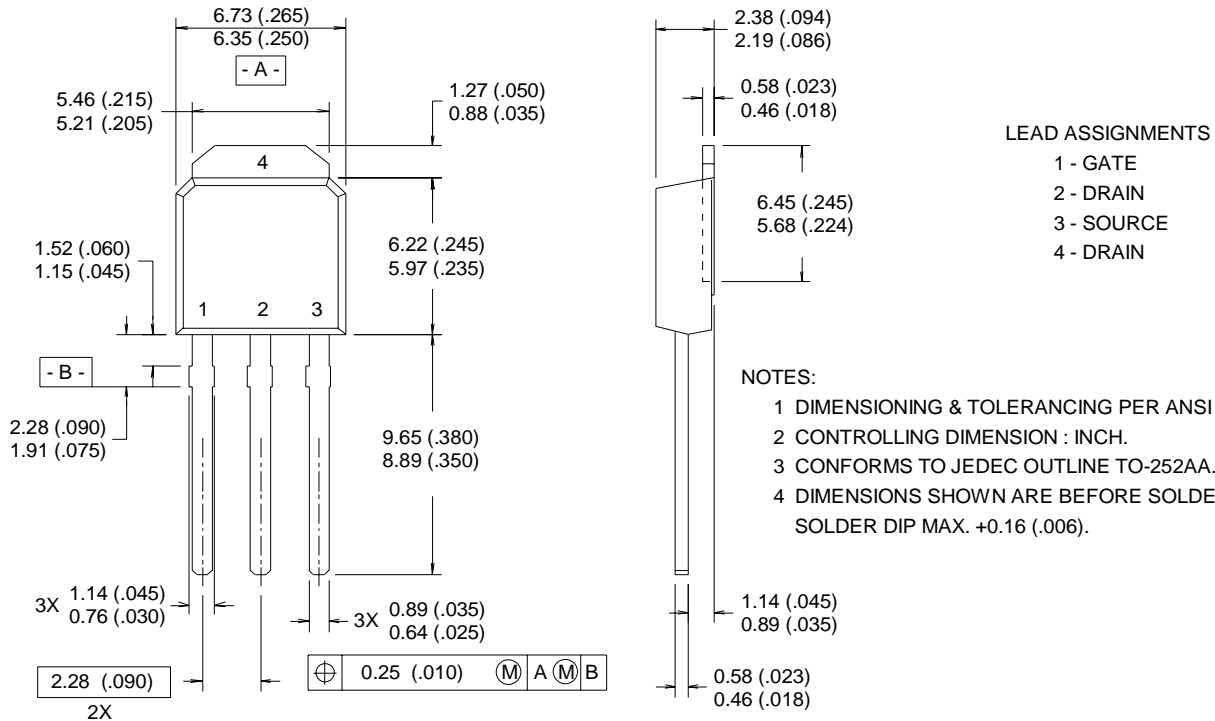

I-Pak (TO-251AA) Part Marking Information

Notes: This part marking information applies to devices produced before 02/26/2001

EXAMPLE: THIS IS AN IRFR120
WITH ASSEMBLY
LOT CODE 9U1P

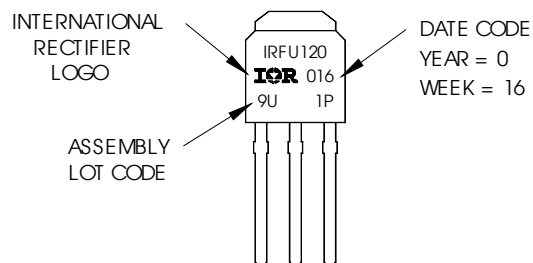

Notes: This part marking information applies to devices produced after 02/26/2001

EXAMPLE: THIS IS AN IRFR120
WITH ASSEMBLY
LOT CODE 5678
ASSEMBLED ON WW 19, 1999
IN THE ASSEMBLY LINE "A"

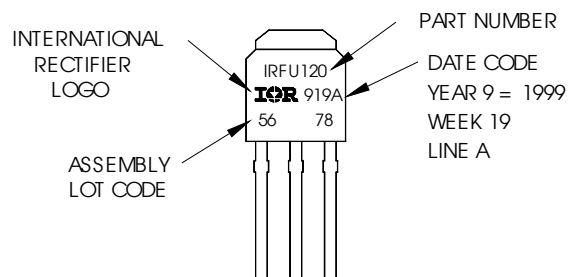

D-Pak (TO-252AA) Tape & Reel Information

Dimensions are shown in millimeters (inches)

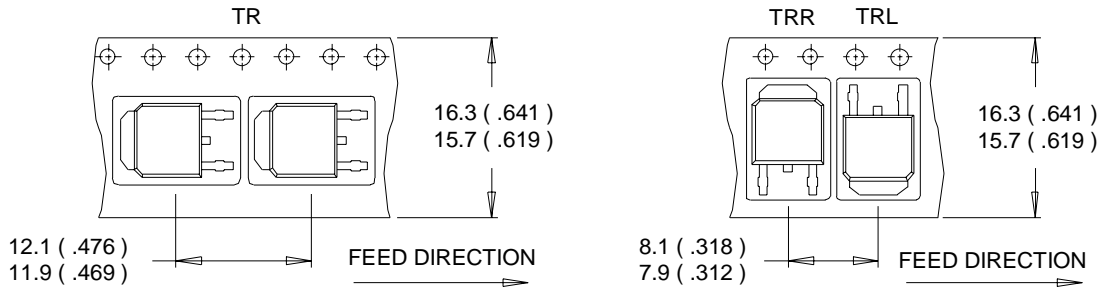

NOTES :

1. CONTROLLING DIMENSION : MILLIMETER.
2. ALL DIMENSIONS ARE SHOWN IN MILLIMETERS (INCHES).
3. OUTLINE CONFORMS TO EIA-481 & EIA-541.

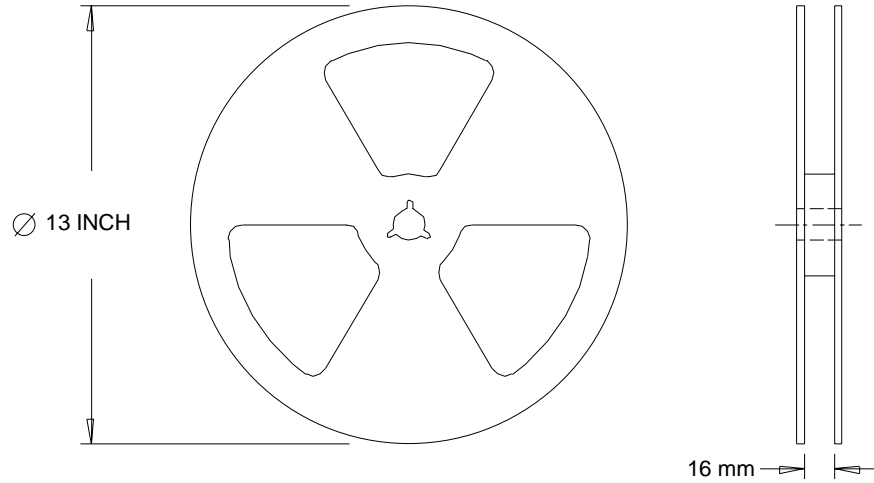

NOTES :

1. OUTLINE CONFORMS TO EIA-481.

IRLR/U9343 & IRLU9343-701

I-Pak Leadform Option 701 Package Outline ⑨

Dimensions are shown in millimeters (inches)

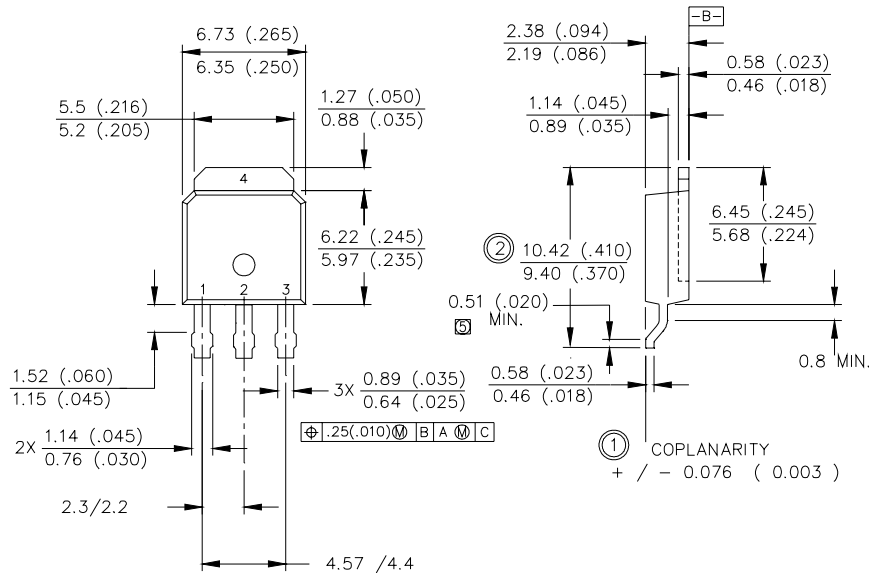

- 1-. GATE
- 2-. DRAIN
- 3-. SOURCE
- 4-. DRAIN

NOTES:

- 1.0 CONTROL DIMENSIONS IN INCHES
- 2.0 PARALLELISM AND ANGULARITY MAX. 0.076 (0.003)
- 3.0 LEADFORM CRITICAL DIMENSIONS DOUBLE RINGED

Notes:

- ① Repetitive rating; pulse width limited by max. junction temperature.
- ② Starting $T_J = 25^\circ\text{C}$, $L = 1.24\text{mH}$, $R_G = 25\Omega$, $I_{AS} = -14\text{A}$.
- ③ Pulse width $\leq 400\mu\text{s}$; duty cycle $\leq 2\%$.
- ④ This only applies for I-Pak, L_S of D-Pak is measured between lead and center of die contact
- ⑤ R_θ is measured at T_J of approximately 90°C .
- ⑥ Contact factory for mounting information
- ⑦ Limited by T_{jmax} . See Figs. 14, 15, 17a, 17b for repetitive avalanche information
- ⑧ When D-Pak mounted on 1" square PCB (FR-4 or G-10 Material) . For recommended footprint and soldering techniques refer to application note #AN-994
- ⑨ Refer to D-Pak package for Part Marking, Tape and Reel information.

Data and specifications subject to change without notice.
This product has been designed for the Industrial market.
Qualification Standards can be found on IR's Web site.