

3-TERMINAL POSITIVE VOLTAGE REGULATOR

■ GENERAL DESCRIPTION

NJM78L00 is 3-terminal positive voltage regulator.
 NJM78L00 series is mounted in EMP8 package of the surface mount package.
 The EMP8 package possible flow soldering.

■ PACKAGE OUTLINE

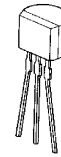

NJM78L00A

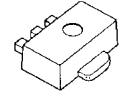

NJM78L00UA



NJM78L00EA
(5V,9V,12V)

■ FEATURES

- Internal Short Circuit Current Limit
- Internal Thermal Overload Protection
- Excellent Ripple Rejection
- Guaranteed 100mA Output Current
- Bipolar Technology
- Package Outline T0-92,SOT-89,EMP8

■ PIN CONFIGURATION

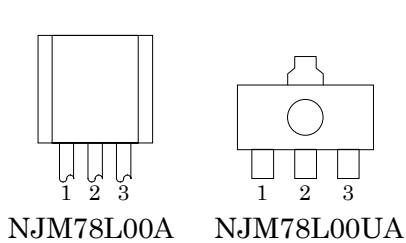

PIN FUNCTION

- 1. OUT
- 2. GND
- 3. IN

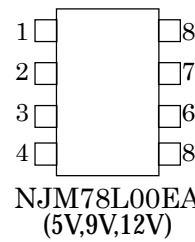

PIN FUNCTION

- 1. OUT
- 2. GND
- 3. GND
- 4. NC
- 5. NC
- 6. GND
- 7. GND
- 8. IN

■ EQUIVALENT CIRCUIT

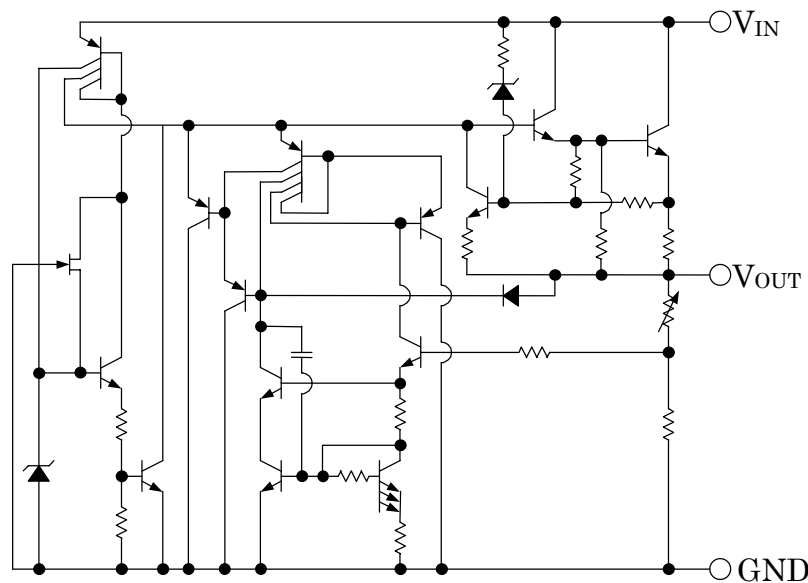

■ ABSOLUTE MAXIMUM RATINGS

(Ta=25°C)

PARAMETER	SYMBOL	MAXIMUM RATINGS	UNIT
Input Voltage	V _{IN}	(78L02A ~ 78L09A) 30 (78L12A ~ 78L15A) 35 (78L18A ~ 78L24A) 40	V
Power Dissipation	P _D	(TO-92) 500 (EMP8) 350 (SOT-89) 300	mW
Operating Temperature Range	Topr	-40 ~ +85	°C
Storage Temperature Range	Tstg	-40 ~ +150	°C

■ ELECTRICAL CHARACTERISTICS(C_{IN}=0.33μF,Co=0.1μF,Tj=25°C)

Measurement is to be conducted is pulse testing.

PARAMETER	SYMBOL	TEST CONDITION	MIN.	TYP.	MAX.	UNIT
NJM78L02A						
Output Voltage	V _O	V _{IN} =9V, I _O =40mA	2.47	2.6	2.73	V
Line Regulation1	ΔV _O -V _{IN} 1	V _{IN} =4.75V ~ 20V, I _O =40mA	-	-	125	mV
Line Regulation2	ΔV _O -V _{IN} 2	V _{IN} =5V ~ 20V, I _O =40mA	-	-	100	mV
Load Regulation1	ΔV _O -I _O 1	V _{IN} =9V, I _O =1 ~ 40mA	-	-	25	mV
Load Regulation2	ΔV _O -I _O 2	V _{IN} =9V, I _O =1 ~ 100mA	-	-	50	mV
Quiescent Current	I _Q	V _{IN} =9V, I _O =0mA	-	2.0	6	mA
Average Temperature Coefficient of Output Voltage	ΔV _O /ΔT	V _{IN} =9V, I _O =1mA	-	0.2	-	mV/°C
Ripple Rejection	RR	6V < V _{IN} < 16V, I _O =40mA e _{in} =1Vp-p, f=120Hz	43	73	-	dB
Output Noise Voltage	V _{NO}	V _{IN} =9V, BW=10Hz ~ 100kHz I _O =40mA	-	35	-	μV
NJM78L03A(*1)						
Output Voltage	V _O	V _{IN} =9V, I _O =40mA	2.85	3.0	3.15	V
Line Regulation1	ΔV _O -V _{IN} 1	V _{IN} =5V ~ 20V, I _O =40mA	-	-	125	mV
Line Regulation2	ΔV _O -V _{IN} 2	V _{IN} =6V ~ 20V, I _O =40mA	-	-	100	mV
Load Regulation1	ΔV _O -I _O 1	V _{IN} =9V, I _O =1 ~ 40mA	-	-	25	mV
Load Regulation2	ΔV _O -I _O 2	V _{IN} =9V, I _O =1 ~ 100mA	-	-	50	mV
Quiescent Current	I _Q	V _{IN} =9V, I _O =0mA	-	2.0	6	mA
Average Temperature Coefficient of Output Voltage	ΔV _O /ΔT	V _{IN} =9V, I _O =1mA	-	0.2	-	mV/°C
Ripple Rejection	RR	6V < V _{IN} < 16V, I _O =40mA e _{in} =1Vp-p, f=120Hz	43	72	-	dB
Output Noise Voltage	V _{NO}	V _{IN} =9V, BW=10Hz ~ 100kHz, I _O =40mA	-	40	-	μV
NJM78L05A(*3)						
Output Voltage	V _O	V _{IN} =10V, I _O =40mA	4.75	5.0	5.25	V
Line Regulation1	ΔV _O -V _{IN} 1	V _{IN} =7V ~ 20V, I _O =40mA	-	-	200	mV
Line Regulation2	ΔV _O -V _{IN} 2	V _{IN} =8V ~ 20V, I _O =40mA	-	-	150	mV
Load Regulation1	ΔV _O -I _O 1	V _{IN} =10V, I _O =1 ~ 40mA	-	-	30	mV
Load Regulation2	ΔV _O -I _O 2	V _{IN} =10V, I _O =1 ~ 100mA	-	-	60	mV
Quiescent Current	I _Q	V _{IN} =10V, I _O =0mA	-	2.0	6	mA
Average Temperature Coefficient of Output Voltage	ΔV _O /ΔT	V _{IN} =10V, I _O =1mA	-	0.4	-	mV/°C
Ripple Rejection	RR	8V < V _{IN} < 18V, I _O =40mA e _{in} =1Vp-p, f=120Hz	40	69	-	dB
Output Noise Voltage	V _{NO}	V _{IN} =10V, BW=10Hz ~ 100kHz I _O =40mA	-	70	-	μV

 (*1):SOT-89 package only.
 (*2):TO-92 package only.
 (*3):SOT-89,TO-92, EMP8

■ ELECTRICAL CHARACTERISTICS($C_{IN}=0.33\mu F, C_o=0.1\mu F, T_j=25^\circ C$)
 Measurement is to be conducted is pulse testing.

PARAMETER	SYMBOL	TEST CONDITION	MIN.	TYP.	MAX.	UNIT
NJM78L06A						
Output Voltage	V_o	$V_{IN}=12V, I_o=40mA$	5.7	6.0	6.3	V
Line Regulation1	ΔV_o-V_{IN1}	$V_{IN}=8.5V \sim 20V, I_o=40mA$	-	-	200	mV
Line Regulation2	ΔV_o-V_{IN2}	$V_{IN}=9V \sim 20V, I_o=40mA$	-	-	150	mV
Load Regulation1	ΔV_o-I_o1	$V_{IN}=12V, I_o=1 \sim 40mA$	-	-	40	mV
Load Regulation2	ΔV_o-I_o2	$V_{IN}=12V, I_o=1 \sim 100mA$	-	-	80	mV
Quiescent Current	I_Q	$V_{IN}=12V, I_o=0mA$	-	2.0	6	mA
Average Temperature	$\Delta V_o/\Delta T$	$V_{IN}=12V, I_o=1mA$	-	0.5	-	mV/°C
Coefficient of Output Voltage						
Ripple Rejection	RR	$9V < V_{IN} < 20V, I_o=40mA$ $e_{in}=1V_{p-p}, f=120Hz$	40	67	-	dB
Output Noise Voltage	V_{NO}	$V_{IN}=12V, BW=10Hz \sim 100kHz$ $I_o=40mA$	-	80	-	μV
NJM78L62A(*2)						
Output Voltage	V_o	$V_{IN}=12.2V, I_o=40mA$	5.89	6.2	6.51	V
Line Regulation1	ΔV_o-V_{IN1}	$V_{IN}=8.7V \sim 20.2V, I_o=40mA$	-	-	200	mV
Line Regulation2	ΔV_o-V_{IN2}	$V_{IN}=9.2V \sim 20.2V, I_o=40mA$	-	-	150	mV
Load Regulation1	ΔV_o-I_o1	$V_{IN}=12.2V, I_o=1 \sim 40mA$	-	-	40	mV
Load Regulation2	ΔV_o-I_o2	$V_{IN}=12.2V, I_o=1 \sim 100mA$	-	-	85	mV
Quiescent Current	I_Q	$V_{IN}=12.2V, I_o=0mA$	-	2.0	6	mA
Average Temperature	$\Delta V_o/\Delta T$	$V_{IN}=12.2V, I_o=1mA$	-	0.5	-	mV/°C
Coefficient of Output Voltage						
Ripple Rejection	RR	$9.2V < V_{IN} < 20.2V, I_o=40mA$ $e_{in}=1V_{p-p}, f=120Hz$	40	67	-	dB
Output Noise Voltage	V_{NO}	$V_{IN}=12.2V, BW=10Hz \sim 100kHz$ $I_o=40mA$	-	85	-	μV
NJM78L07A						
Output Voltage	V_o	$V_{IN}=13V, I_o=40mA$	6.65	7.0	7.35	V
Line Regulation1	ΔV_o-V_{IN1}	$V_{IN}=9.5V \sim 22V, I_o=40mA$	-	-	210	mV
Line Regulation2	ΔV_o-V_{IN2}	$V_{IN}=10V \sim 22V, I_o=40mA$	-	-	160	mV
Load Regulation1	ΔV_o-I_o1	$V_{IN}=13V, I_o=1 \sim 40mA$	-	-	45	mV
Load Regulation2	ΔV_o-I_o2	$V_{IN}=13V, I_o=1 \sim 100mA$	-	-	90	mV
Quiescent Current	I_Q	$V_{IN}=13V, I_o=0mA$	-	2.1	6	mA
Average Temperature	$\Delta V_o/\Delta T$	$V_{IN}=13V, I_o=1mA$	-	0.55	-	mV/°C
Coefficient of Output Voltage						
Ripple Rejection	RR	$10V < V_{IN} < 20V, I_o=40mA$ $e_{in}=1V_{p-p}, f=120Hz$	39	66	-	dB
Output Noise Voltage	V_{NO}	$V_{IN}=13V, BW=10Hz \sim 100kHz$ $I_o=40mA$	-	100	-	μV
NJM78L08A						
Output Voltage	V_o	$V_{IN}=14V, I_o=40mA$	7.6	8.0	8.4	V
Line Regulation1	ΔV_o-V_{IN1}	$V_{IN}=10.5V \sim 23V, I_o=40mA$	-	-	225	mV
Line Regulation2	ΔV_o-V_{IN2}	$V_{IN}=11V \sim 23V, I_o=40mA$	-	-	175	mV
Load Regulation1	ΔV_o-I_o1	$V_{IN}=14V, I_o=1 \sim 40mA$	-	-	50	mV
Load Regulation2	ΔV_o-I_o2	$V_{IN}=14V, I_o=1 \sim 100mA$	-	-	100	mV
Quiescent Current	I_Q	$V_{IN}=14V, I_o=0mA$	-	2.1	6	mA
Average Temperature	$\Delta V_o/\Delta T$	$V_{IN}=14V, I_o=1mA$	-	0.6	-	mV/°C
Coefficient of Output Voltage						
Ripple Rejection	RR	$11V < V_{IN} < 20V, I_o=40mA$ $e_{in}=1V_{p-p}, f=120Hz$	39	66	-	dB
Output Noise Voltage	V_{NO}	$V_{IN}=14V, BW=10Hz \sim 100kHz$ $I_o=40mA$	-	115	-	μV

(*1):SOT-89 package only.

(*2):TO-92 package only.

(*3):SOT-89,TO-92, EMP8

■ ELECTRICAL CHARACTERISTICS($C_{IN}=0.33\mu F, C_o=0.1\mu F, T_j=25^\circ C$)
 Measurement is to be conducted is pulse testing.

PARAMETER	SYMBOL	TEST CONDITION	MIN.	TYP.	MAX.	UNIT
NJM78L09A(*3)						
Output Voltage	V_o	$V_{IN}=15V, I_o=40mA$	8.55	9.0	9.45	V
Line Regulation1	ΔV_o-V_{IN1}	$V_{IN}=11.5V \sim 23V, I_o=40mA$	—	—	250	mV
Line Regulation2	ΔV_o-V_{IN2}	$V_{IN}=12V \sim 23V, I_o=40mA$	—	—	200	mV
Load Regulation1	ΔV_o-I_o1	$V_{IN}=15V, I_o=1 \sim 40mA$	—	—	50	mV
Load Regulation2	ΔV_o-I_o2	$V_{IN}=15V, I_o=1 \sim 100mA$	—	—	100	mV
Quiescent Current	I_Q	$V_{IN}=15V, I_o=0mA$	—	2.1	6	mA
Average Temperature	$\Delta V_o/\Delta T$	$V_{IN}=15V, I_o=1mA$	—	0.65	—	mV/°C
Coefficient of Output Voltage						
Ripple Rejection	RR	$12V < V_{IN} < 21V, I_o=40mA$ $e_{in}=1Vp-p, f=120Hz$	38	65	—	dB
Output Noise Voltage	V_{NO}	$V_{IN}=15V, BW=10Hz \sim 100kHz$ $I_o=40mA$	—	125	—	μV
NJM78L10A						
Output Voltage	V_o	$V_{IN}=16V, I_o=40mA$	9.5	10.0	10.5	V
Line Regulation1	ΔV_o-V_{IN1}	$V_{IN}=13V \sim 25V, I_o=40mA$	—	—	250	mV
Line Regulation2	ΔV_o-V_{IN2}	$V_{IN}=14V \sim 25V, I_o=40mA$	—	—	200	mV
Load Regulation1	ΔV_o-I_o1	$V_{IN}=16V, I_o=1 \sim 40mA$	—	—	50	mV
Load Regulation2	ΔV_o-I_o2	$V_{IN}=16V, I_o=1 \sim 100mA$	—	—	100	mV
Quiescent Current	I_Q	$V_{IN}=16V, I_o=0mA$	—	2.1	6	mA
Average Temperature	$\Delta V_o/\Delta T$	$V_{IN}=16V, I_o=1mA$	—	0.7	—	mV/°C
Coefficient of Output Voltage						
Ripple Rejection	RR	$13V < V_{IN} < 22V, I_o=40mA$ $e_{in}=1Vp-p, f=120Hz$	37	64	—	dB
Output Noise Voltage	V_{NO}	$V_{IN}=16V, BW=10Hz \sim 100kHz$ $I_o=40mA$	—	135	—	μV
NJM78L12A(*3)						
Output Voltage	V_o	$V_{IN}=19V, I_o=40mA$	11.4	12.0	12.6	V
Line Regulation1	ΔV_o-V_{IN1}	$V_{IN}=14.5V \sim 27V, I_o=40mA$	—	—	250	mV
Line Regulation2	ΔV_o-V_{IN2}	$V_{IN}=16V \sim 27V, I_o=40mA$	—	—	200	mV
Load Regulation1	ΔV_o-I_o1	$V_{IN}=19V, I_o=1 \sim 40mA$	—	—	50	mV
Load Regulation2	ΔV_o-I_o2	$V_{IN}=19V, I_o=1 \sim 100mA$	—	—	100	mV
Quiescent Current	I_Q	$V_{IN}=19V, I_o=0mA$	—	2.1	6.5	mA
Average Temperature	$\Delta V_o/\Delta T$	$V_{IN}=19V, I_o=1mA$	—	0.9	—	mV/°C
Coefficient of Output Voltage						
Ripple Rejection	RR	$15V < V_{IN} < 25V, I_o=40mA$ $e_{in}=1Vp-p, f=120Hz$	37	62	—	dB
Output Noise Voltage	V_{NO}	$V_{IN}=19V, BW=10Hz \sim 100kHz$ $I_o=40mA$	—	160	—	μV
NJM78L15A						
Output Voltage	V_o	$V_{IN}=23V, I_o=40mA$	14.3	15.0	15.7	V
Line Regulation1	ΔV_o-V_{IN1}	$V_{IN}=17.5V \sim 30V, I_o=40mA$	—	—	300	mV
Line Regulation2	ΔV_o-V_{IN2}	$V_{IN}=20V \sim 30V, I_o=40mA$	—	—	250	mV
Load Regulation1	ΔV_o-I_o1	$V_{IN}=23V, I_o=1 \sim 40mA$	—	—	75	mV
Load Regulation2	ΔV_o-I_o2	$V_{IN}=23V, I_o=1 \sim 100mA$	—	—	150	mV
Quiescent Current	I_Q	$V_{IN}=23V, I_o=0mA$	—	2.2	6.5	mA
Average Temperature	$\Delta V_o/\Delta T$	$V_{IN}=23V, I_o=1mA$	—	1.0	—	mV/°C
Coefficient of Output Voltage						
Ripple Rejection	RR	$18.5V < V_{IN} < 28.5V, I_o=40mA$ $e_{in}=1Vp-p, f=120Hz$	34	60	—	dB
Output Noise Voltage	V_{NO}	$V_{IN}=23V, BW=10Hz \sim 100kHz$ $I_o=40mA$	—	190	—	μV

(*1):SOT-89 package only.

(*2):TO-92 package only.

(*3):SOT-89,TO-92, EMP8

■ ELECTRICAL CHARACTERISTICS($C_{IN}=0.33\mu F, C_o=0.1\mu F, T_j=25^\circ C$)
 Measurement is to be conducted is pulse testing.

PARAMETER	SYMBOL	TEST CONDITION	MIN.	TYP.	MAX.	UNIT
NJM78L18A						
Output Voltage	V_o	$V_{IN}=27V, I_o=40mA$	17.1	18.0	18.9	V
Line Regulation1	ΔV_o-V_{IN1}	$V_{IN}=22V \sim 33V, I_o=40mA$	-	-	320	mV
Line Regulation2	ΔV_o-V_{IN2}	$V_{IN}=23V \sim 33V, I_o=40mA$	-	-	270	mV
Load Regulation1	ΔV_o-I_o1	$V_{IN}=27V, I_o=1 \sim 40mA$	-	-	80	mV
Load Regulation2	ΔV_o-I_o2	$V_{IN}=27V, I_o=1 \sim 100mA$	-	-	160	mV
Quiescent Current	I_Q	$V_{IN}=27V, I_o=0mA$	-	2.2	6.5	mA
Average Temperature	$\Delta V_o/\Delta T$	$V_{IN}=27V, I_o=1mA$	-	1.1	-	mV/°C
Coefficient of Output Voltage						
Ripple Rejection	RR	$23V < V_{IN} < 33V, I_o=40mA$ $e_{in}=1Vp-p, f=120Hz$	33	59	-	dB
Output Noise Voltage	V_{NO}	$V_{IN}=27V, BW=10Hz \sim 100kHz$ $I_o=40mA$	-	230	-	μV
NJM78L20A						
Output Voltage	V_o	$V_{IN}=29V, I_o=40mA$	19.0	20.0	21.0	V
Line Regulation1	ΔV_o-V_{IN1}	$V_{IN}=23V \sim 34V, I_o=40mA$	-	-	330	mV
Line Regulation2	ΔV_o-V_{IN2}	$V_{IN}=24V \sim 34V, I_o=40mA$	-	-	280	mV
Load Regulation1	ΔV_o-I_o1	$V_{IN}=29V, I_o=1 \sim 40mA$	-	-	90	mV
Load Regulation2	ΔV_o-I_o2	$V_{IN}=29V, I_o=1 \sim 100mA$	-	-	180	mV
Quiescent Current	I_Q	$V_{IN}=29V, I_o=0mA$	-	2.3	7	mA
Average Temperature	$\Delta V_o/\Delta T$	$V_{IN}=29V, I_o=1mA$	-	1.2	-	mV/°C
Coefficient of Output Voltage						
Ripple Rejection	RR	$24V < V_{IN} < 34V, I_o=40mA$ $e_{in}=1Vp-p, f=120Hz$	32	58	-	dB
Output Noise Voltage	V_{NO}	$V_{IN}=29V, BW=10Hz \sim 100kHz$ $I_o=40mA$	-	250	-	μV
NJM78L24A						
Output Voltage	V_o	$V_{IN}=33V, I_o=40mA$	22.8	24	25.2	V
Line Regulation1	ΔV_o-V_{IN1}	$V_{IN}=27V \sim 38V, I_o=40mA$	-	-	350	mV
Line Regulation2	ΔV_o-V_{IN2}	$V_{IN}=28V \sim 38V, I_o=40mA$	-	-	300	mV
Load Regulation1	ΔV_o-I_o1	$V_{IN}=33V, I_o=1 \sim 40mA$	-	-	100	mV
Load Regulation2	ΔV_o-I_o2	$V_{IN}=33V, I_o=1 \sim 100mA$	-	-	200	mV
Quiescent Current	I_Q	$V_{IN}=33V, I_o=0mA$	-	2.3	7	mA
Average Temperature	$\Delta V_o/\Delta T$	$V_{IN}=33V, I_o=1mA$	-	1.4	-	mV/°C
Coefficient of Output Voltage						
Ripple Rejection	RR	$27.5V < V_{IN} < 37.5V, I_o=40mA$ $e_{in}=1Vp-p, f=120Hz$	32	57	-	dB
Output Noise Voltage	V_{NO}	$V_{IN}=33V, BW=10Hz \sim 100kHz$ $I_o=40mA$	-	280	-	μV

(*1):SOT-89 package only.
 (*2):TO-92 package only.
 (*3):SOT-89,TO-92, EMP8

■ SOT-89 MARK

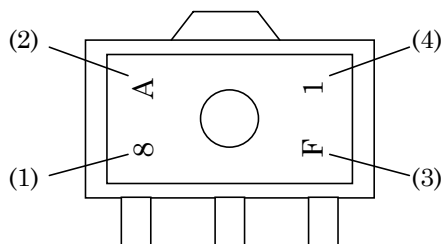

- (1) 8 : Positive Output
 - (2) Vo Rank
 - (3) The end of A.D.
 - (4) Production Mouth
- Oct. ... X
 Nov. ... Y
 Dec. ... Z

NJM78L02A	8	A
NJM78L03A	8	B
NJM78L05A	8	C
NJM78L06A	8	E
NJM78L62A	8	Z
NJM78L07A	8	F
NJM78L08A	8	G
NJM78L09A	8	H
NJM78L10A	8	J
NJM78L12A	8	K
NJM78L15A	8	L
NJM78L18A	8	M
NJM78L20A	8	N
NJM78L24A	8	P

NJM78L00

■ TEST CIRCUIT

1. Output Voltage, Line Regulation, Load Regulation, Quiescent Current, Average Temperature Coefficient of Output Voltage, Output Noise Voltage, Peak Output/Short-Circuit Current
2. Ripple Rejection

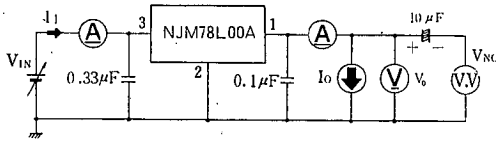

○ Measurement is to be conducted in pulse testing.
 ○ $I_Q = I_1 - I_0$

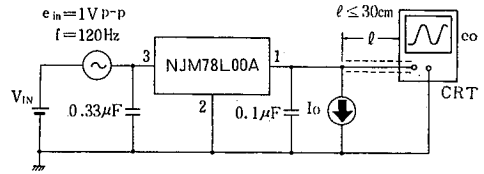

$$RR = 20 \log_{10} \left(\frac{e_{in}}{e_o} \right) \text{ (dB)}$$

■ AMBIENT TEMPERATURE VS. POWER DISSIPATION

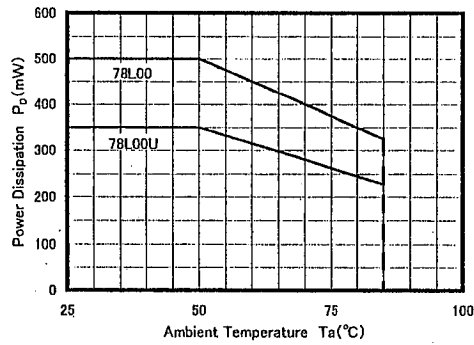

■ TYPICAL CHARACTERISTICS

NJM78L05/L12/L24
Output Characteristics
 ($I_O = 0 \text{ mA}$, $T_j = 25^\circ\text{C}$)

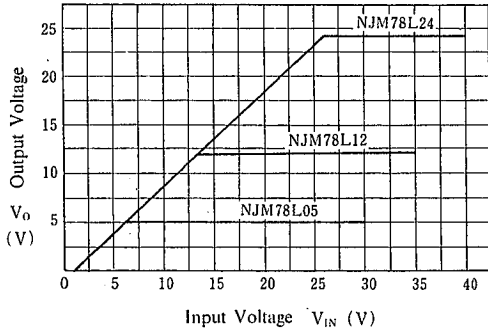

NJM78L05 Dropout Characteristics
 ($T_j = 25^\circ\text{C}$)

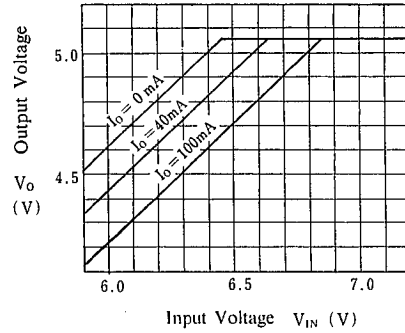

NJM78L00 Series Short Circuit
Output Current
 ($T_j = 25^\circ\text{C}$)

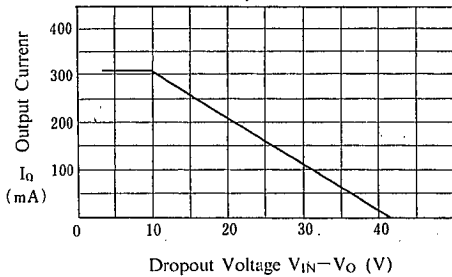

NJM78L02/L24 Quiescent Current
vs. Output Current
 ($T_j = 25^\circ\text{C}$)

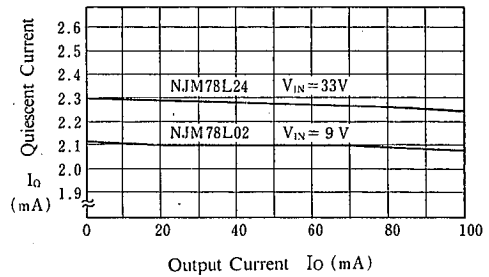

NJM78L05 Quiescent Current
vs. Input Voltage
 ($I_O = 0 \text{ mA}$, $T_j = 25^\circ\text{C}$)

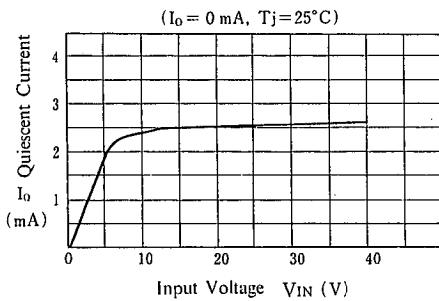

■ TYPICAL CHARACTERISTICS

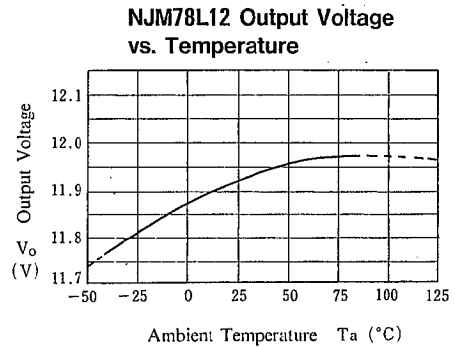
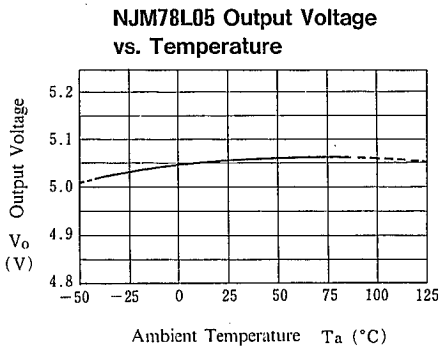
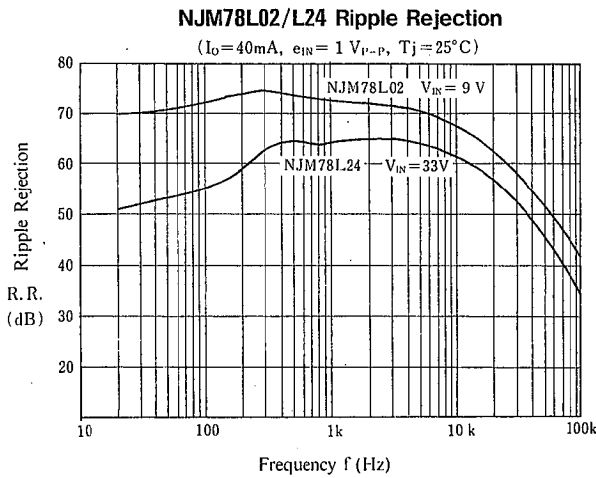
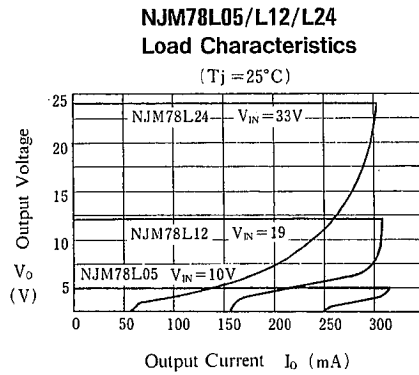
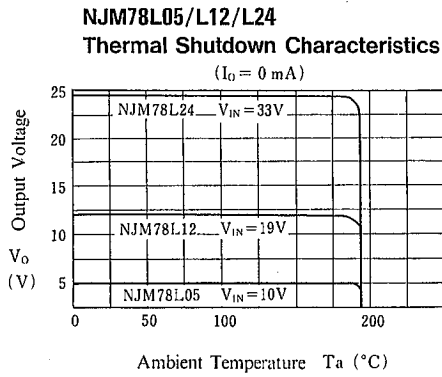

6

MEMO

[CAUTION]

The specifications on this databook are only given for information, without any guarantee as regards either mistakes or omissions. The application circuits in this databook are described only to show representative usages of the product and not intended for the guarantee or permission of any right including the industrial rights.