

### Features

- Low ON resistance.
- Ultrahigh-speed switching.
- High-speed diode built in ( $t_{rr} = 140\text{ns}$ ).
- Micaless package facilitating easy mounting.

### Absolute Maximum Ratings at $T_a = 25^\circ\text{C}$

			unit
Drain-to-Source Voltage	$V_{DSS}$	600	V
Gate-to-Source Voltage	$V_{GSS}$	$\pm 30$	V
Drain Current(DC)	$I_D$	5.5	A
Drain Current(Pulse)	$I_{DP}$	22	A
Allowable Power Dissipation	$P_D$	2.0	W
		35	W
		150	$^\circ\text{C}$
Channel Temperature	$T_{ch}$		
Storage Temperature	$T_{stg}$	-55 to +150	$^\circ\text{C}$

### Electrical Characteristics at $T_a = 25^\circ\text{C}$

			min	typ	max	unit
D-S Breakdown Voltage	$V_{(BR)DSS}$	$I_D = 10\text{mA}, V_{GS} = 0$	600			V
Zero-Gate Voltage Drain Current	$I_{DSS}$	$V_{DS} = 480\text{V}, V_{GS} = 0$			1.0	mA
Gate-to-Source Leakage Current	$I_{GSS}$	$V_{GS} = \pm 30\text{V}, V_{DS} = 0$			$\pm 100$	nA
Cutoff Voltage	$V_{GS(off)}$	$V_{DS} = 10\text{V}, I_D = 1\text{mA}$	2.0		3.0	V
Forward Transfer Admittance	$ Y_{fs} $	$V_{DS} = 10\text{V}, I_D = 3\text{A}$	2.3	4.5		S
Static Drain-to-Source ON-State Resistance	$R_{DS(on)}$	$I_D = 3\text{A}, V_{GS} = 10\text{V}$		1.1	1.5	$\Omega$
Input Capacitance	$C_{iss}$	$V_{DS} = 20\text{V}, f = 1\text{MHz}$		1100		pF
Output Capacitance	$C_{oss}$	$V_{DS} = 20\text{V}, f = 1\text{MHz}$		150		pF
Reverse Transfer Capacitance	$C_{rss}$	$V_{DS} = 20\text{V}, f = 1\text{MHz}$		45		pF
Turn-ON Delay Time	$t_{d(on)}$	See specified Test Circuit.		18		ns
Rise Time	$t_r$	"		25		ns
Turn-OFF Delay Time	$t_{d(off)}$	"		240		ns
Fall Time	$t_f$	"		60		ns
Diode Forward Voltage	$V_{SD}$	$I_S = 5.5\text{A}, V_{GS} = 0$			1.5	V
Diode Reverse Recovery Time	$t_{rr}$	$I_S = 5.5\text{A}, di/dt = 100\text{A}/\mu\text{s}$		140		ns

(Note) Be careful in handling the 2SK2045 because it has no protection diode between gate and source.

### Switching Time Test Circuit

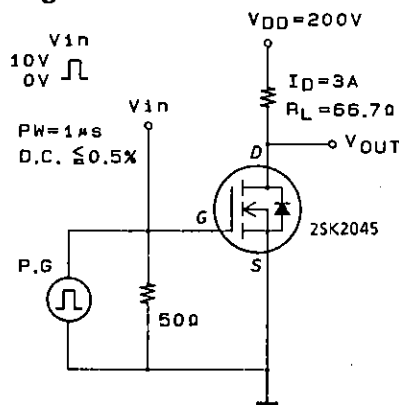

### Package Dimensions 2078B

(unit : mm)

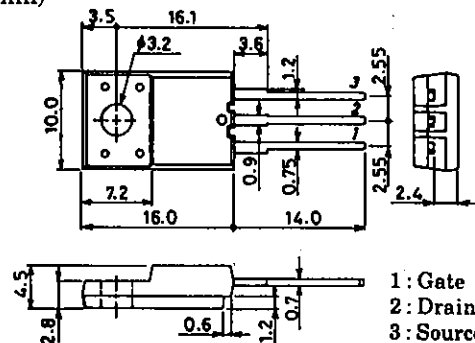

SANYO : TO-220FI(LS)

**SANYO Electric Co., Ltd. Semiconductor Business Headquarters**  
TOKYO OFFICE Tokyo Bldg., 1-10, 1 Chome, Ueno, Taito-ku, TOKYO, 110 JAPAN

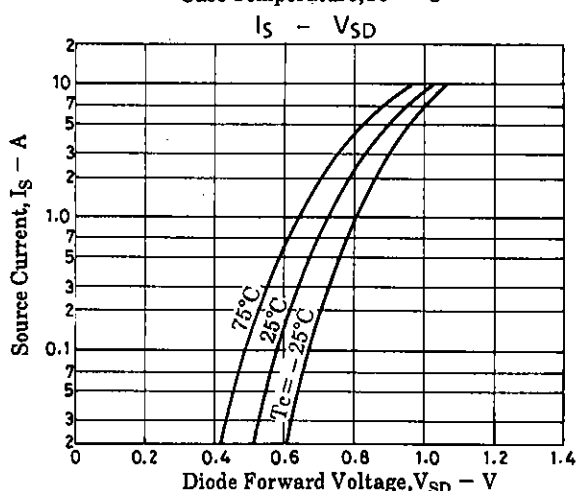
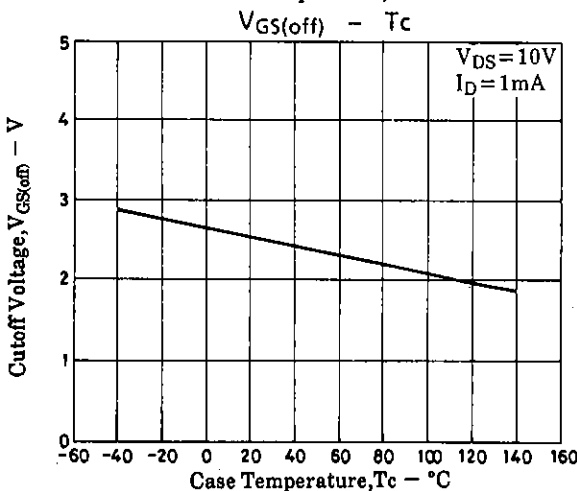
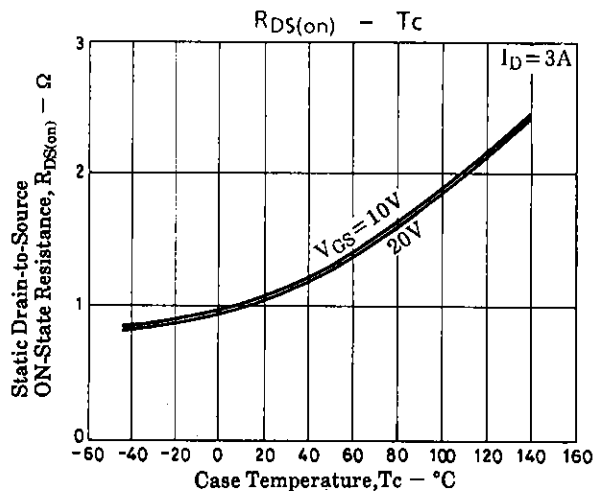
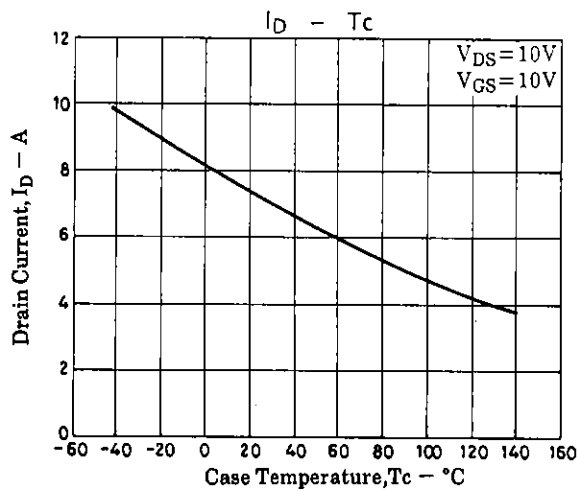
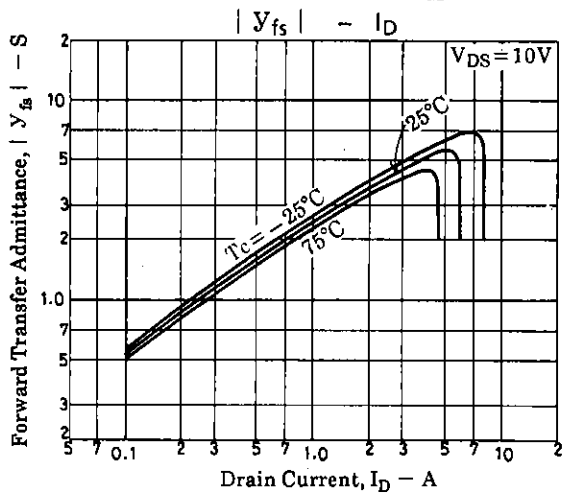
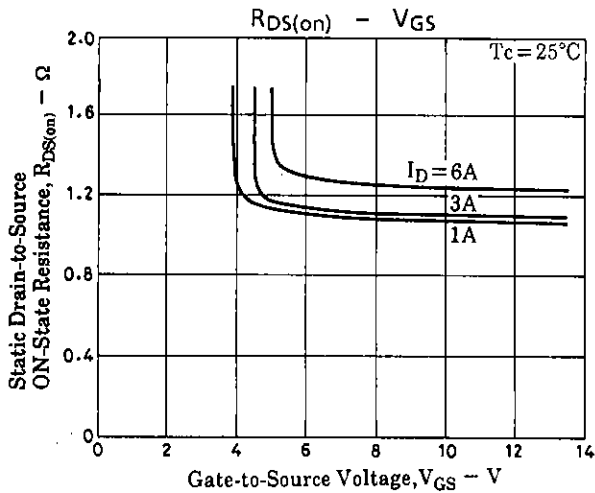
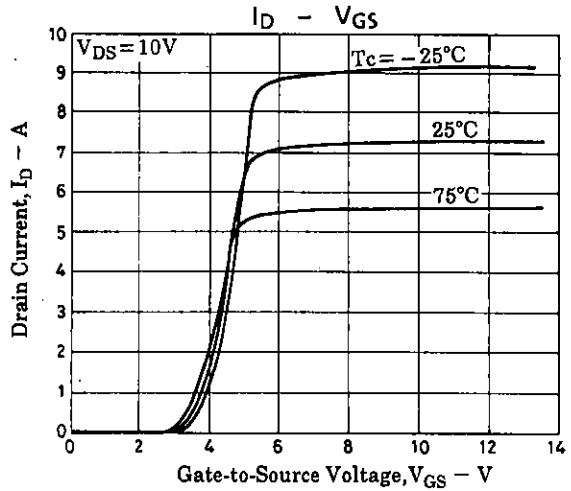
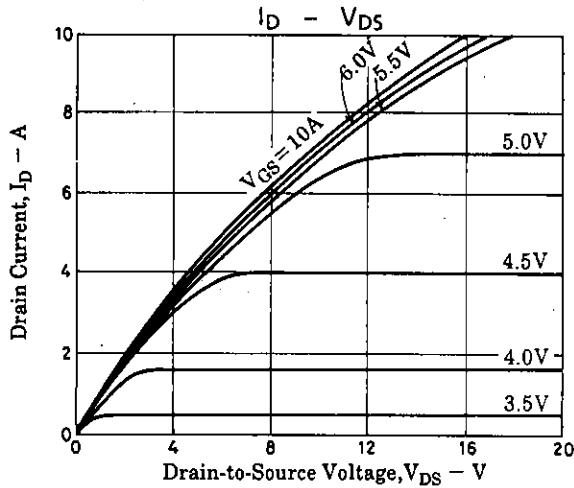

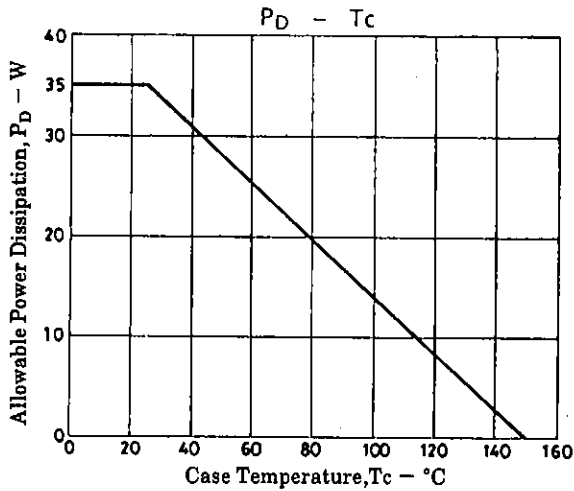
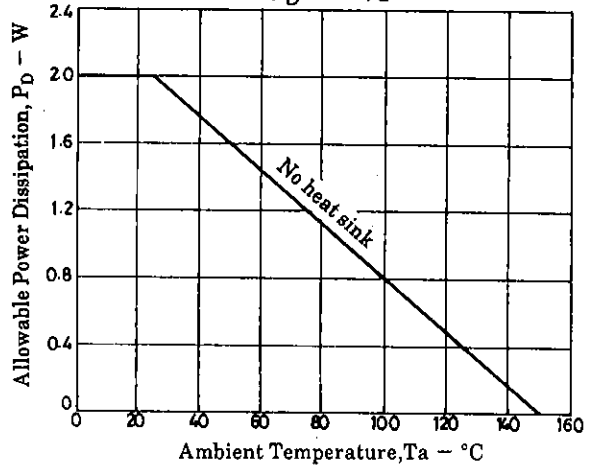
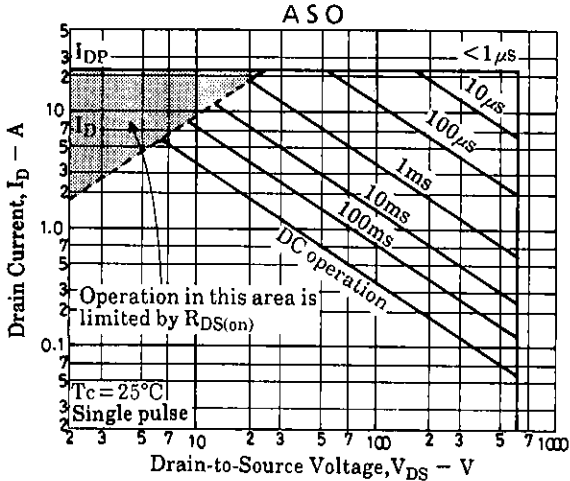
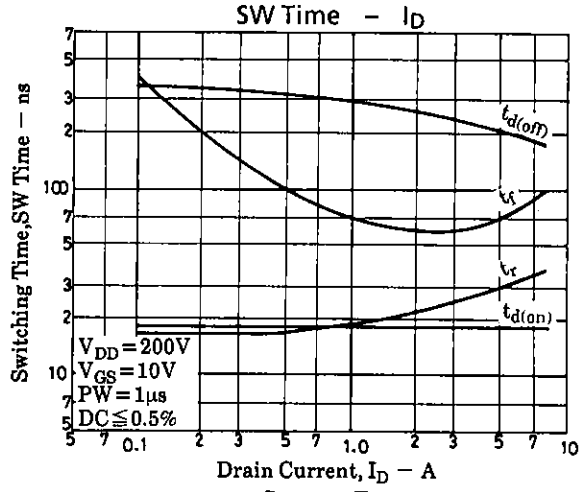
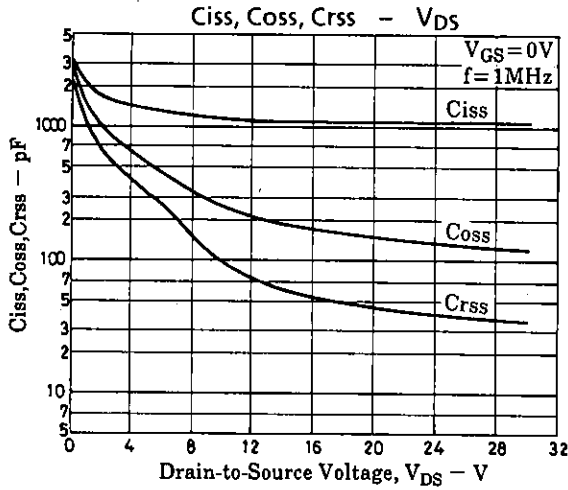

■ No products described or contained herein are intended for use in surgical implants, life-support systems, aerospace equipment, nuclear power control systems, vehicles, disaster/crime-prevention equipment and the like, the failure of which may directly or indirectly cause injury, death or property loss.

■ Anyone purchasing any products described or contained herein for an above-mentioned use shall:

- ① Accept full responsibility and indemnify and defend SANYO ELECTRIC CO., LTD., its affiliates, subsidiaries and distributors and all their officers and employees, jointly and severally, against any and all claims and litigation and all damages, cost and expenses associated with such use.
- ② Not impose any responsibility for any fault or negligence which may be cited in any such claim or litigation on SANYO ELECTRIC CO., LTD., its affiliates, subsidiaries and distributors or any of their officers and employees jointly or severally.

■ Information (including circuit diagrams and circuit parameters) herein is for example only; it is not guaranteed for volume production. SANYO believes information herein is accurate and reliable, but no guarantees are made or implied regarding its use or any infringements of intellectual property rights or other rights of third parties.

This catalog provides information as of July, 1997. Specifications and information herein are subject to change without notice.