

### FEATURES

**Low supply current: 250  $\mu$ A max**  
**Very low input bias current: 1 pA max**  
**Low offset voltage: 750  $\mu$ V max**  
**Single-supply operation: 5 V to 26 V**  
**Dual-supply operation:  $\pm 2.5$  V to  $\pm 13$  V**  
**Rail-to-rail output**  
**Unity gain stable**  
**No phase reversal**  
**SC70 package**

### APPLICATIONS

**Line-/battery-powered instruments**  
**Photodiode amplifiers**  
**Precision current sensing**  
**Medical instrumentation**  
**Industrial controls**  
**Precision filters**  
**Portable audio**  
**ATE**

### GENERAL DESCRIPTION

The AD8641 is a low power, precision JFET input amplifier featuring extremely low input bias current and rail-to-rail output. The ability to swing nearly rail-to-rail at the input and rail-to-rail at the output enables designers to buffer CMOS DACs, ASICs, and other wide output swing devices in single-supply systems. The outputs remain stable with capacitive loads of more than 500 pF.

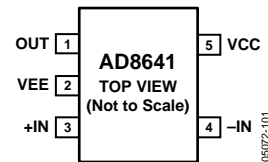

Figure 1. 5-Lead SC70 (KS-5)

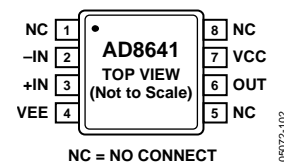

Figure 2. 8-Lead SOIC (R-8)

The AD8641 is suitable for applications utilizing multichannel boards that require low power to manage heat. Other applications include photodiodes, ATE reference level drivers, battery management, and industrial controls.

The AD8641 is fully specified over the extended industrial temperature range of  $-40^{\circ}$  to  $+125^{\circ}$ C. The AD8641 is available in 5-lead SC70 and 8-lead SOIC lead-free packages.

#### Rev. 0

Information furnished by Analog Devices is believed to be accurate and reliable. However, no responsibility is assumed by Analog Devices for its use, nor for any infringements of patents or other rights of third parties that may result from its use. Specifications subject to change without notice. No license is granted by implication or otherwise under any patent or patent rights of Analog Devices. Trademarks and registered trademarks are the property of their respective owners.

**TABLE OF CONTENTS**

Specifications.....	3	Outline Dimensions .....	12
Electrical Characteristics .....	3	Ordering Guide .....	12
Absolute Maximum Ratings.....	5		
Typical Performance Characteristics .....	6		

**REVISION HISTORY**

10/04—Initial Version: Revision 0

## SPECIFICATIONS

### ELECTRICAL CHARACTERISTICS

@  $V_S = 5.0\text{ V}$ ,  $V_{CM} = 2.5\text{ V}$ ,  $T_A = 25^\circ\text{C}$ , unless otherwise noted.

Table 1.

Parameter	Symbol	Conditions	Min	Typ	Max	Unit
INPUT CHARACTERISTICS						
Offset Voltage	$V_{OS}$	$-40^\circ\text{C} < T_A < +85^\circ\text{C}$ $+85^\circ\text{C} < T_A < +125^\circ\text{C}$ , $V_{CM} = 1.5\text{ V}$		50	750	$\mu\text{V}$ mV mV
Input Bias Current	$I_B$	$-40^\circ\text{C} < T_A < +125^\circ\text{C}$		0.25	1	pA pA
Input Offset Current	$I_{OS}$	$-40^\circ\text{C} < T_A < +125^\circ\text{C}$			50	pA pA
Input Voltage Range			0		3	V
Common-Mode Rejection Ratio	CMRR	$V_{CM} = 0\text{ V to } 2.5\text{ V}$	74	93		dB
Large Signal Voltage Gain	$A_{VO}$	$R_L = 10\text{ k}\Omega$ , $V_O = 0.5\text{ to } 4.5\text{ V}$	80	140		V/mV
Offset Voltage Drift	$\Delta V_{OS}/\Delta T$	$-40^\circ\text{C} < T_A < +125^\circ\text{C}$		2.5		$\mu\text{V}/^\circ\text{C}$
OUTPUT CHARACTERISTICS						
Output Voltage High	$V_{OH}$	$I_L = 2\text{ mA}$ , $-40^\circ\text{C to } +125^\circ\text{C}$	4.94			V
Output Voltage Low	$V_{OL}$	$I_L = 2\text{ mA}$ , $-40^\circ\text{C to } +125^\circ\text{C}$	4.93		0.05	V V
Output Current	$I_{OUT}$			0.01 $\pm 6$	0.05	V mA
POWER SUPPLY						
Power Supply Rejection Ratio	PSRR	$V_S = 5\text{ V to } 26\text{ V}$	90	107		dB
Supply Current/Amplifier	$I_{SY}$	$-40^\circ\text{C} < T_A < +125^\circ\text{C}$		195	250 270	$\mu\text{A}$ $\mu\text{A}$
DYNAMIC PERFORMANCE						
Slew Rate	SR			2		V/ $\mu\text{s}$
Gain Bandwidth Product	GBP			3		MHz
Phase Margin	$\phi_O$			50		Degrees
NOISE PERFORMANCE						
Voltage Noise	$e_N$ p-p	$f = 0.1\text{ Hz to } 10\text{ Hz}$		4.0		$\mu\text{V p-p}$
Voltage Noise Density	$e_N$	$f = 1\text{ kHz}$		28.5		nV/ $\sqrt{\text{Hz}}$
Current Noise Density	$i_N$	$f = 1\text{ kHz}$		0.5		fA/ $\sqrt{\text{Hz}}$

# AD8641

@  $V_S = \pm 13\text{ V}$ ,  $V_{CM} = 0\text{ V}$ ,  $T_A = 25^\circ\text{C}$ , unless otherwise noted.

**Table 2.**

Parameter	Symbol	Conditions	Min	Typ	Max	Unit
<b>INPUT CHARACTERISTICS</b>						
Offset Voltage	$V_{OS}$	$-40^\circ < T_A < +125^\circ\text{C}$		70	750	$\mu\text{V}$
Input Bias Current	$I_B$	$-40^\circ < T_A < +125^\circ\text{C}$		0.25	1	$\text{pA}$
Input Offset Current	$I_{OS}$	$-40^\circ < T_A < +125^\circ\text{C}$			260	$\text{pA}$
Input Voltage Range		$-40^\circ < T_A < +125^\circ\text{C}$	-13		35	$\text{pA}$
Common-Mode Rejection Ratio	CMRR	$V_{CM} = -13\text{ V to } +10\text{ V}$	90	107	+10	$\text{dB}$
Large Signal Voltage Gain	$A_{VO}$	$R_L = 10\text{ k}\Omega$ , $V_O = -11\text{ V to } +11\text{ V}$	215	290		$\text{V/mV}$
Offset Voltage Drift	$\Delta V_{OS}/\Delta T$	$-40^\circ < T_A < +125^\circ\text{C}$		2.5		$\mu\text{V}/^\circ\text{C}$
<b>OUTPUT CHARACTERISTICS</b>						
Output Voltage High	$V_{OH}$	$I_L = 2\text{ mA}$ , $-40^\circ\text{C to } +125^\circ\text{C}$	+12.94			$\text{V}$
Output Voltage Low	$V_{OL}$	$I_L = 2\text{ mA}$ , $-40^\circ\text{C to } +125^\circ\text{C}$	+12.93		+12.94	$\text{V}$
Output Current	$I_{OUT}$			$\pm 12$	-12.93	$\text{mA}$
<b>POWER SUPPLY</b>						
Power Supply Rejection Ratio	PSRR	$V_S = \pm 2.5\text{ V to } \pm 13\text{ V}$	90	107		$\text{dB}$
Supply Current/Amplifier	$I_{SY}$	$-40^\circ < T_A < +125^\circ\text{C}$		200	290	$\mu\text{A}$
					330	$\mu\text{A}$
<b>DYNAMIC PERFORMANCE</b>						
Slew Rate	SR			3		$\text{V}/\mu\text{s}$
Gain Bandwidth Product	GBP			3.5		$\text{MHz}$
Phase Margin	$\angle\phi_o$			60		Degrees
<b>NOISE PERFORMANCE</b>						
Voltage Noise	$e_N$ p-p	$f = 0.1\text{ Hz to } 10\text{ Hz}$		4.2		$\mu\text{V p-p}$
Voltage Noise Density	$e_N$	$f = 1\text{ kHz}$		27.5		$\text{nV}/\sqrt{\text{Hz}}$
Current Noise Density	$i_N$	$f = 1\text{ kHz}$		0.5		$\text{fA}/\sqrt{\text{Hz}}$

## ABSOLUTE MAXIMUM RATINGS

Table 3. Absolute Maximum Ratings<sup>1</sup>

Parameter	Rating
Supply Voltage	27.3 V
Input Voltage	VS- to VS+
Differential Input Voltage	±Supply Voltage
Output Short-Circuit Duration	Indefinite
Storage Temperature Range	
KS-5, R-8 Packages	-65°C to +150°C
Operating Temperature Range	-40°C to +125°C
Junction Temperature Range	
KS-5, R-8 Packages	-65°C to +150°C
Lead Temperature Range (Soldering, 60 Sec)	300°C

Table 4.

Package Type	$\theta_{JA}$ <sup>2</sup>	$\theta_{JC}$	Units
5-Lead SC70 (KS-5)	331.4	223.9	°C/W
8-Lead SOIC (R-8)	157	56	°C/W

Stresses above those listed under Absolute Maximum Ratings may cause permanent damage to the device. This is a stress rating only; functional operation of the device at these or any other conditions above those listed in the operational sections of this specification is not implied. Exposure to absolute maximum rating conditions for extended periods may affect device reliability.

<sup>1</sup> Absolute maximum ratings apply at 25°C, unless otherwise noted.

<sup>2</sup>  $\theta_{JA}$  is specified for the worst-case conditions, i.e.,  $\theta_{JA}$  is specified for devices soldered on circuit boards for surface-mounted packages.

### ESD CAUTION

ESD (electrostatic discharge) sensitive device. Electrostatic charges as high as 4000 V readily accumulate on the human body and test equipment and can discharge without detection. Although this product features proprietary ESD protection circuitry, permanent damage may occur on devices subjected to high energy electrostatic discharges. Therefore, proper ESD precautions are recommended to avoid performance degradation or loss of functionality.



TYPICAL PERFORMANCE CHARACTERISTICS

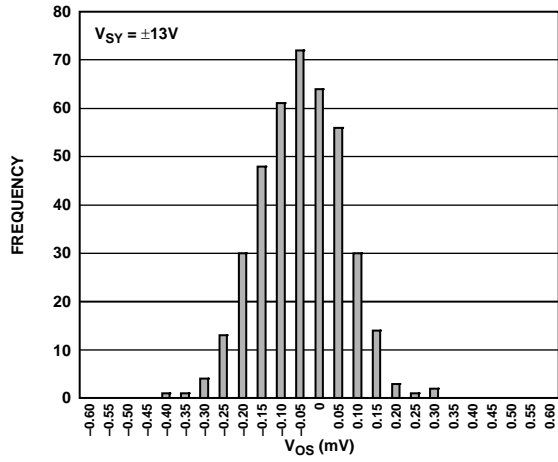

Figure 3. Input Offset Voltage

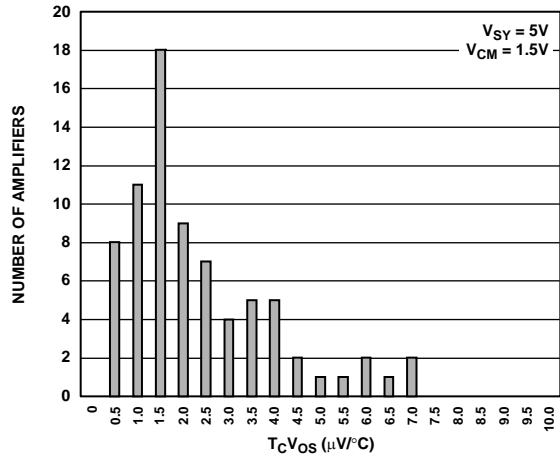

Figure 6. Offset Voltage Drift

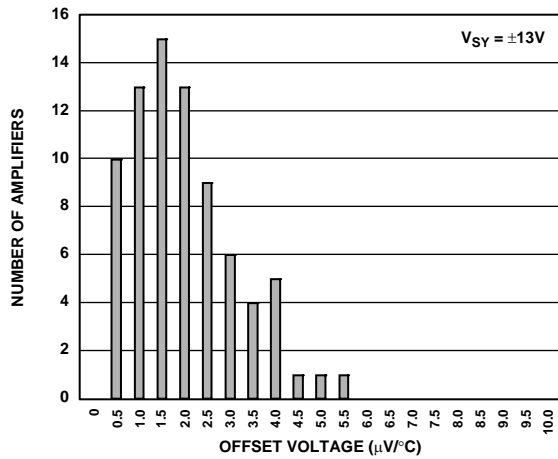

Figure 4. Offset Voltage Drift

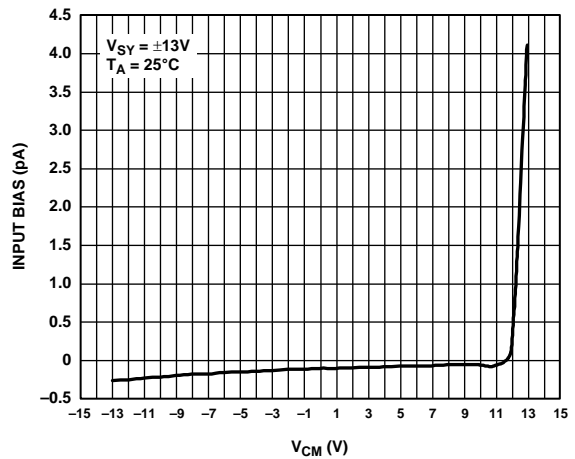

Figure 7. Input Bias Current vs.  $V_{CM}$

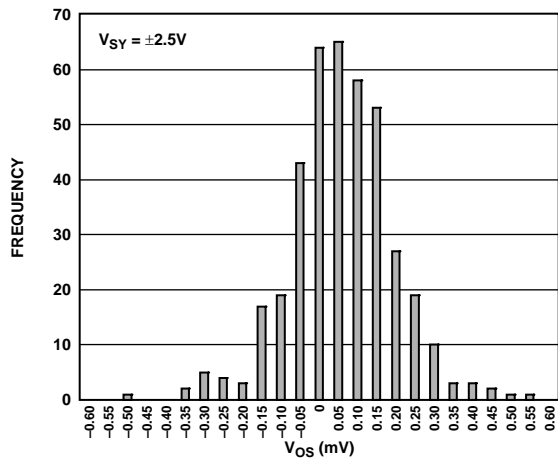

Figure 5. Input Offset Voltage

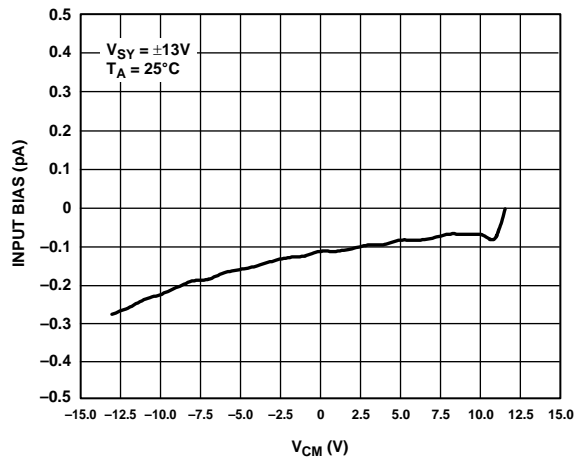

Figure 8. Input Bias Current vs.  $V_{CM}$

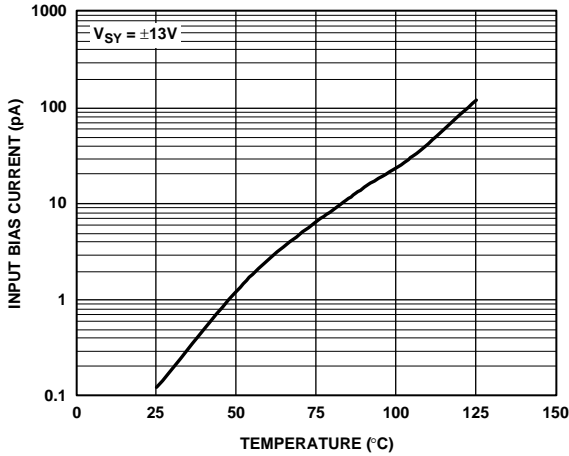

Figure 9. Input Bias Current vs. Temperature

05072-008

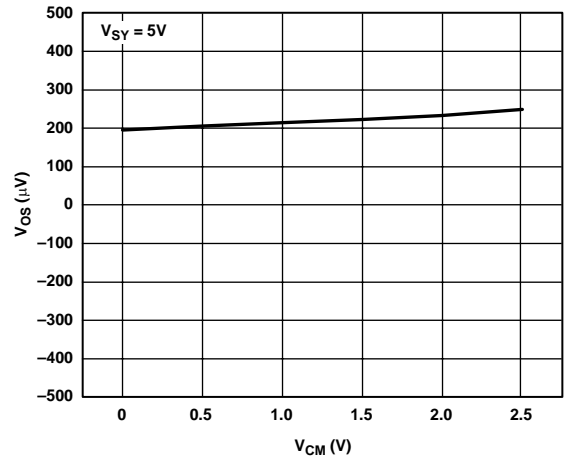

Figure 12. Input Offset Voltage vs.  $V_{CM}$

05072-011

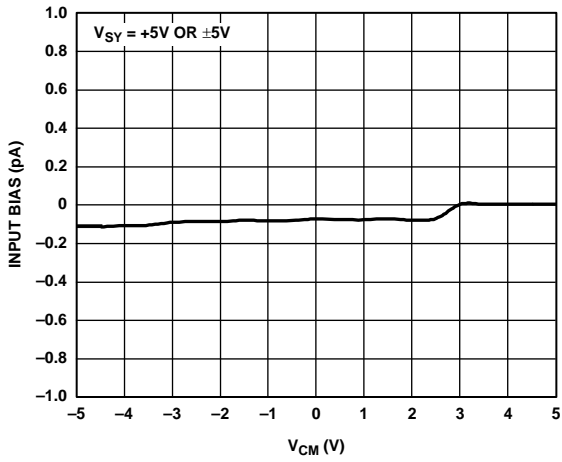

Figure 10. Input Bias Current vs.  $V_{CM}$

05072-009

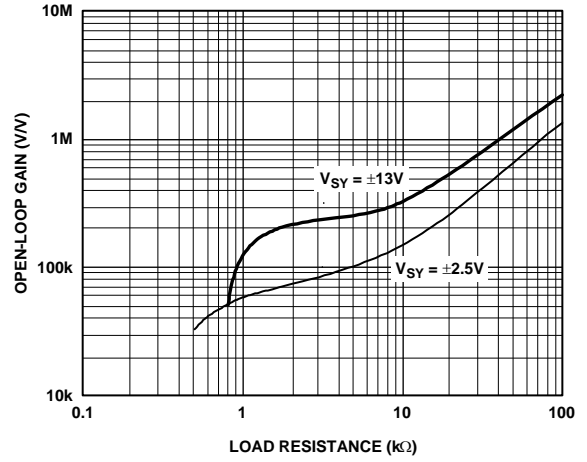

Figure 13. Open-Loop Gain vs. Load Resistance

05072-012

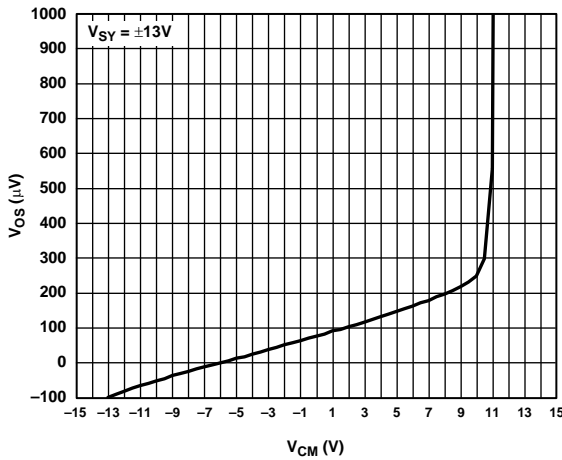

Figure 11. Input Offset Voltage vs.  $V_{CM}$

05072-010

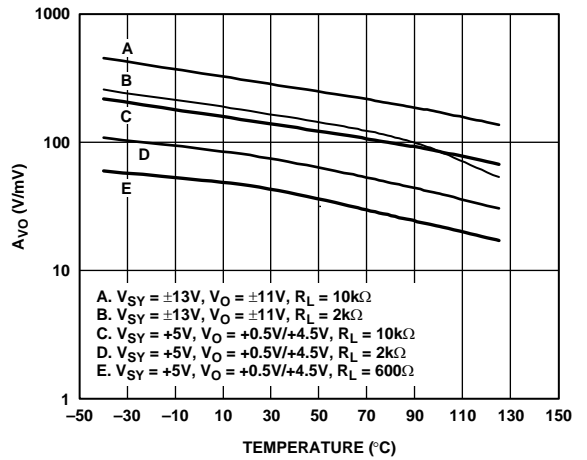

Figure 14. Open-Loop Gain vs. Temperature

05072-013

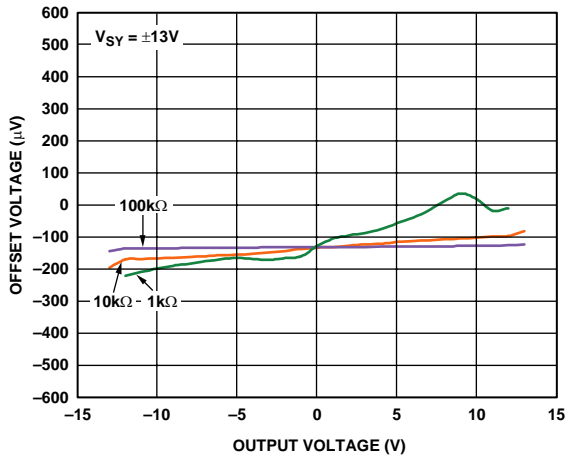

Figure 15. Input Error Voltage vs. Output Voltage for Resistive Loads

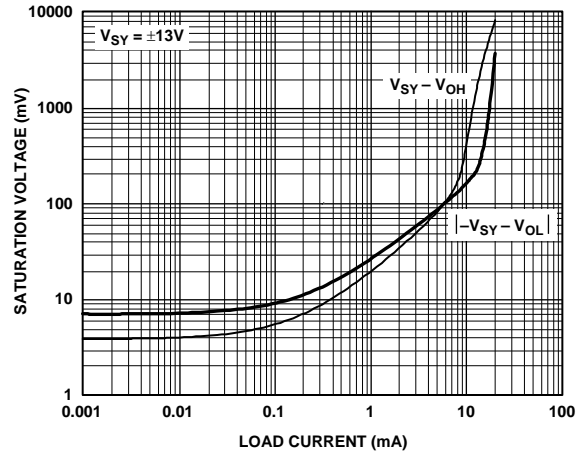

Figure 18. Output Saturation Voltage vs. Load Current

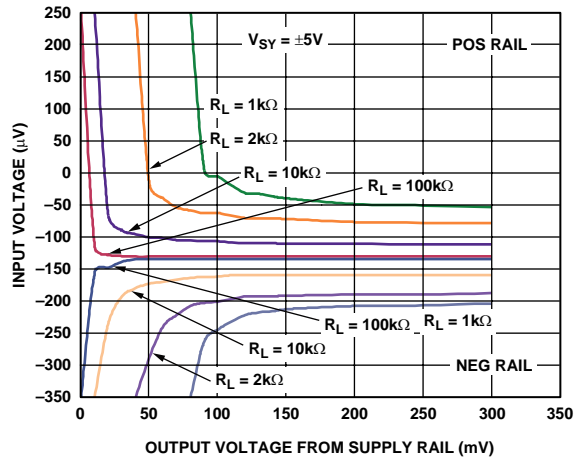

Figure 16. Input Error Voltage vs. Output Voltage Within 300 mV of Supply Rails

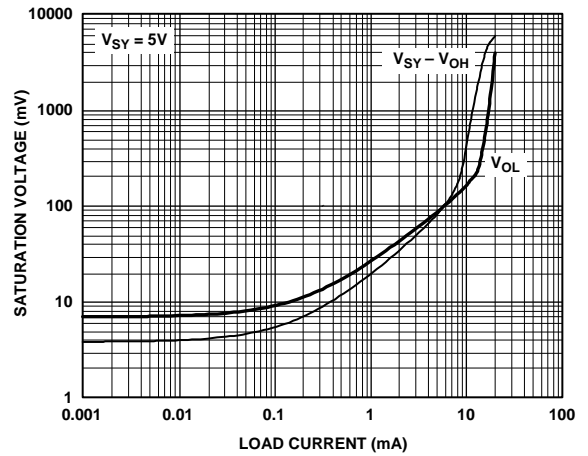

Figure 19. Output Saturation Voltage vs. Load Current

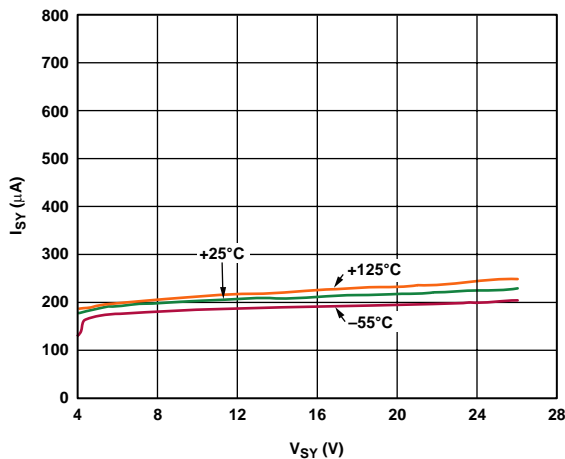

Figure 17. Quiescent Current vs. Supply Voltage at Different Temperatures

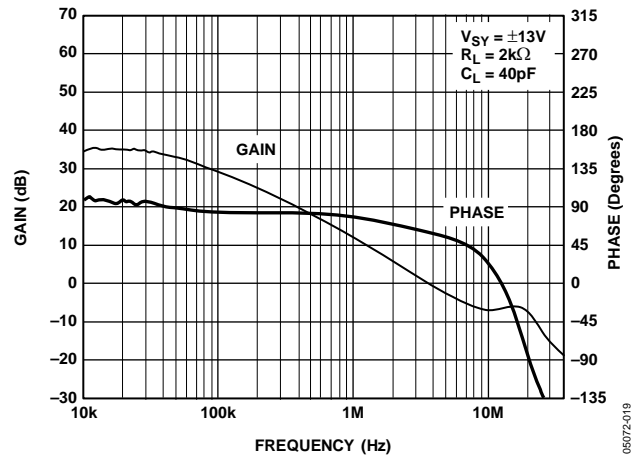

Figure 20. Open-Loop Gain and Phase Margin vs. Frequency



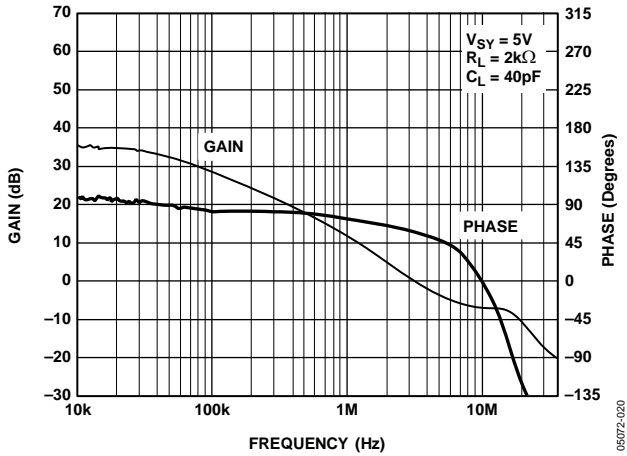

Figure 21. Open-Loop Gain and Phase Margin vs. Frequency

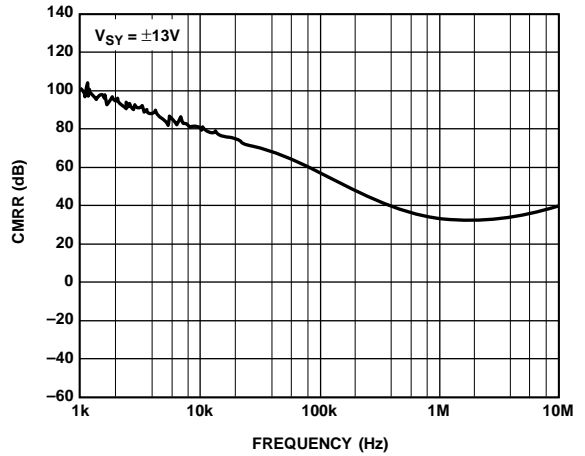

Figure 24. CMRR vs. Frequency

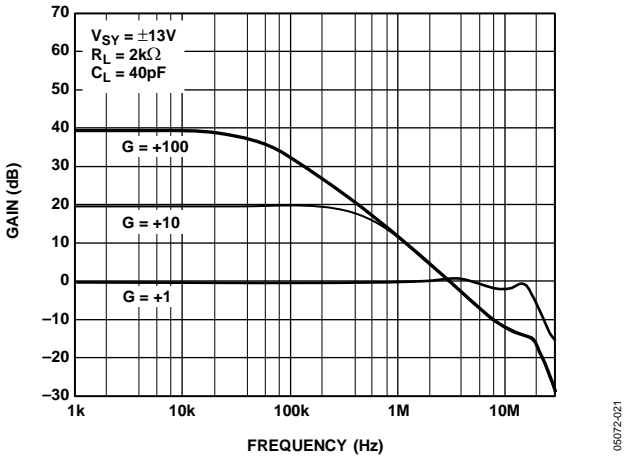

Figure 22. Closed-Loop Gain vs. Frequency

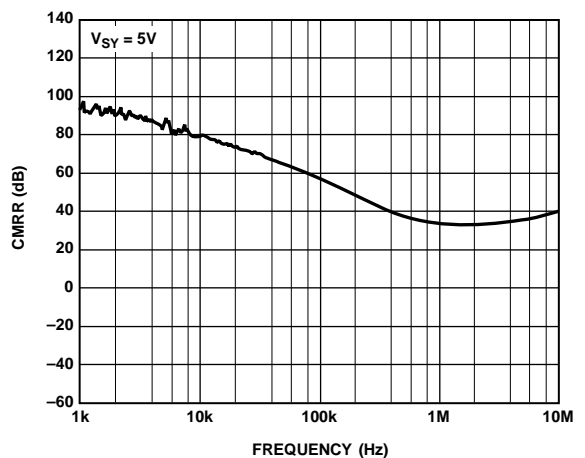

Figure 25. CMRR vs. Frequency

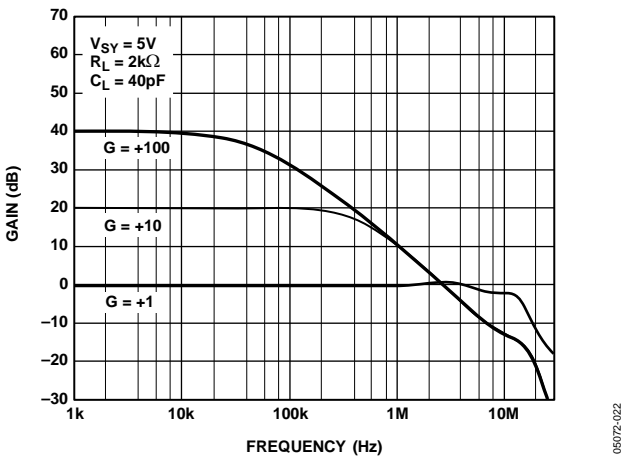

Figure 23. Closed-Loop Gain vs. Frequency

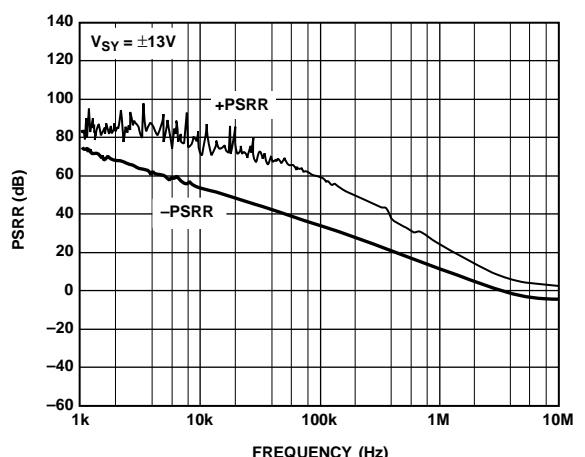

Figure 26. PSRR vs. Frequency

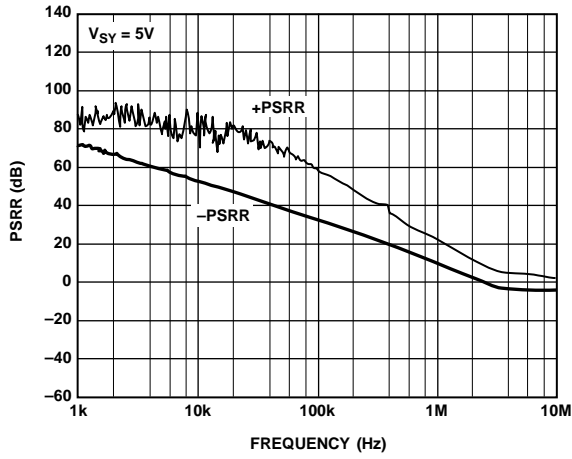

Figure 27. PSRR vs. Frequency

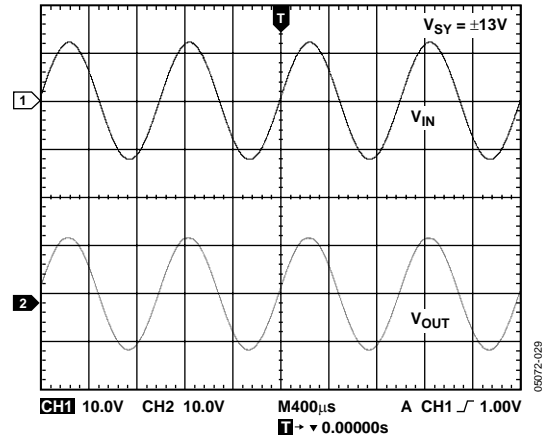

Figure 30. No Phase Reversal

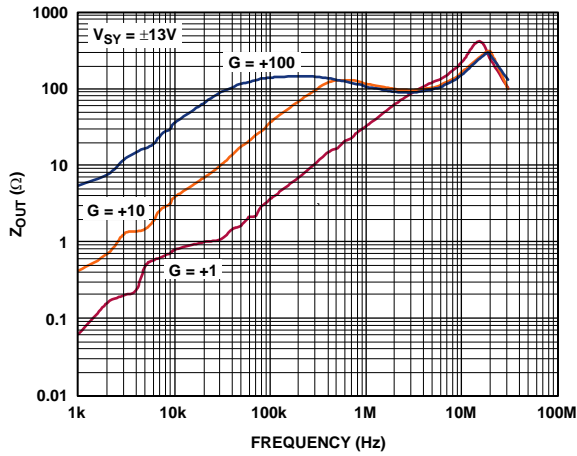

Figure 28. Output Impedance vs. Frequency

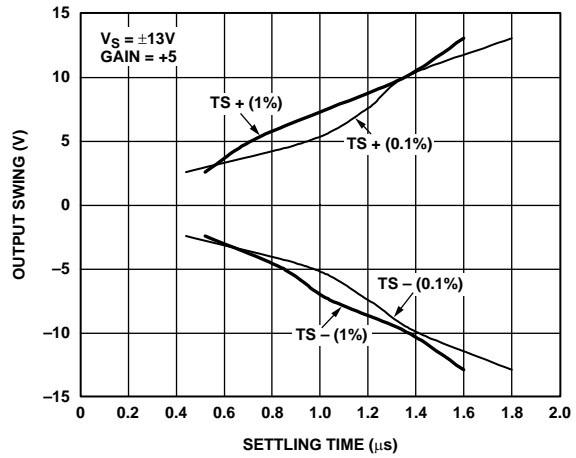

Figure 31. Output Swing and Error vs. Settling Time

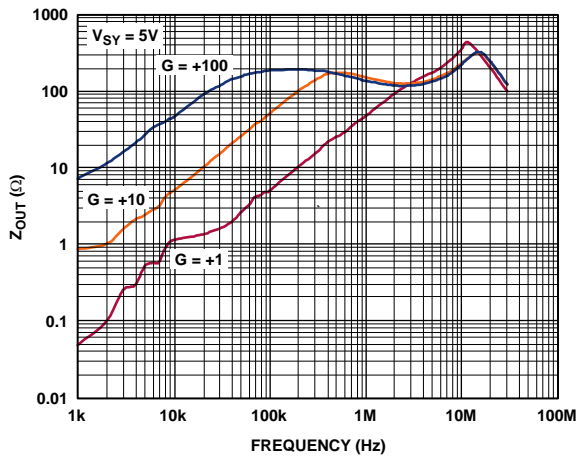

Figure 29. Output Impedance vs. Frequency

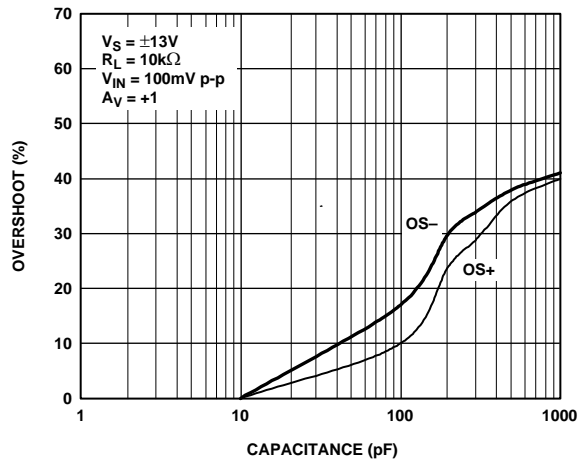

Figure 32. Small Signal Overshoot vs. Load Capacitance

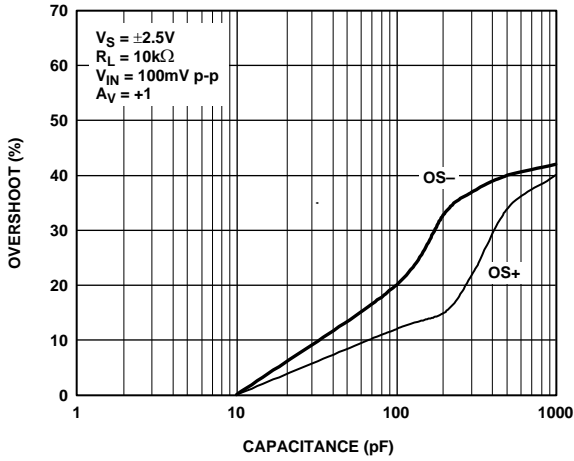

Figure 33. Small Signal Overshoot vs. Load Capacitance

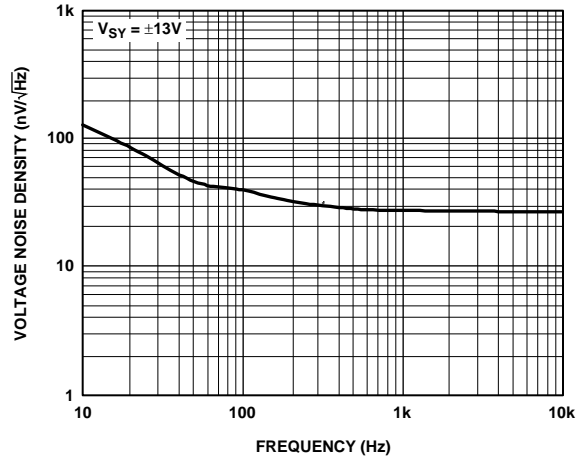

Figure 36. Voltage Noise Density

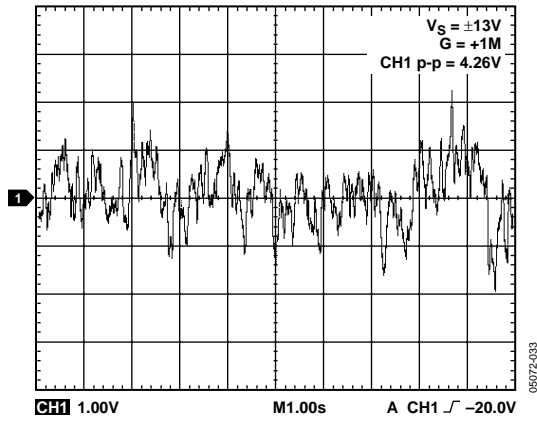

Figure 34. 0.1 Hz to 10 Hz Noise

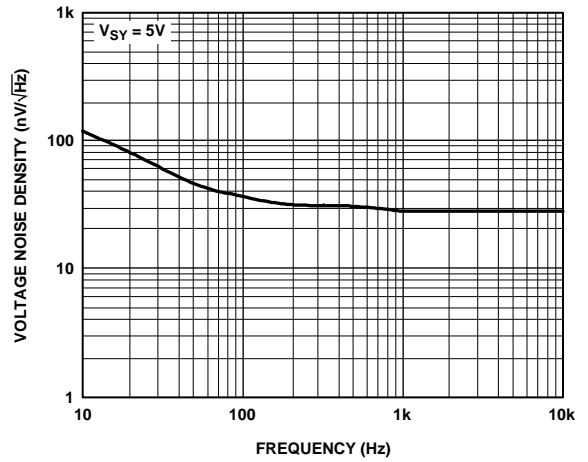

Figure 37. Voltage Noise Density

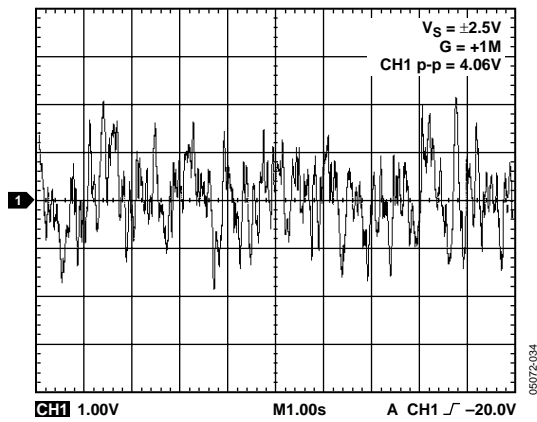

Figure 35. 0.1 Hz to 10 Hz Noise

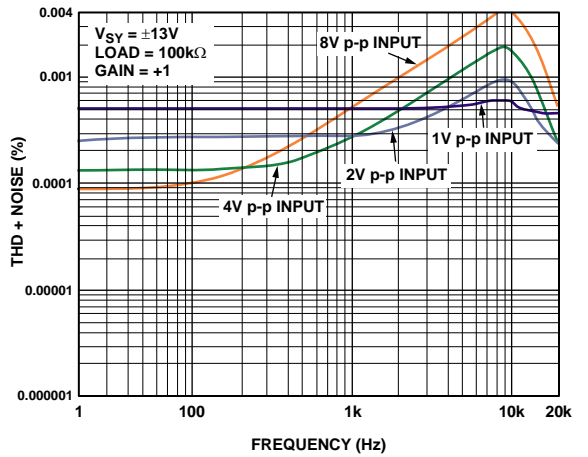

Figure 38. Total Harmonic Distortion + Noise vs. Frequency

OUTLINE DIMENSIONS

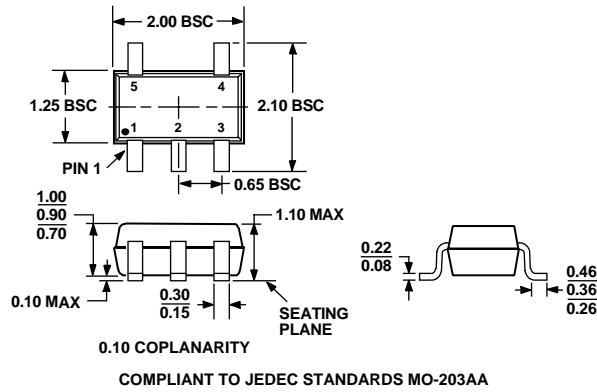

Figure 39. 5-Lead Thin Shrink Small Outline Transistor Package [SC70] (KS-5)  
Dimensions shown in millimeters

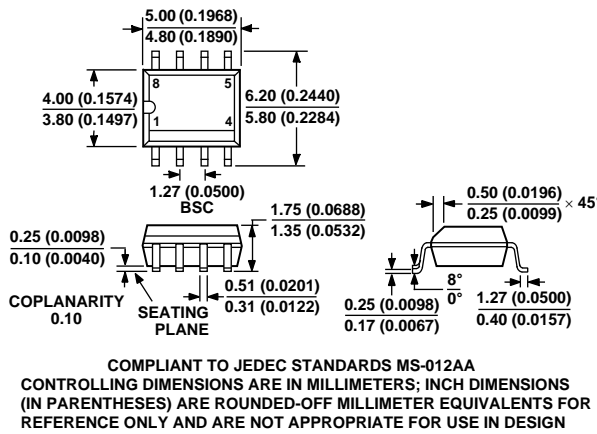

Figure 40. 8-Lead Standard Small Outline Package [SOIC] (R-8)  
Dimensions shown in millimeters

ORDERING GUIDE

Model	Temperature Range	Package Description	Package Option	Branding
AD8641AKSZ-R2 <sup>1</sup>	-40°C to +125°C	5-Lead SC70	KS-5	A07
AD8641AKSZ-Reel <sup>1</sup>	-40°C to +125°C	5-Lead SC70	KS-5	A07
AD8641AKSZ-Reel <sup>1</sup>	-40°C to +125°C	5-Lead SC70	KS-5	A07
AD8641ARZ <sup>1</sup>	-40°C to +125°C	8-lead SOIC	R-8	
AD8641ARZ-Reel <sup>1</sup>	-40°C to +125°C	8-lead SOIC	R-8	
AD8641ARZ-Reel <sup>1</sup>	-40°C to +125°C	8-lead SOIC	R-8	

<sup>1</sup> Z = Pb-free part.